

**CONNECTORS  
FOR THE  
HIGHEST  
TEMPERATURE  
RANGE**

**STECKVERBIN-  
DUNGEN FÜR  
HÖCHSTE  
TEMPERATUR-  
MESSBEREICHE**

**THERMO  
SERIES**

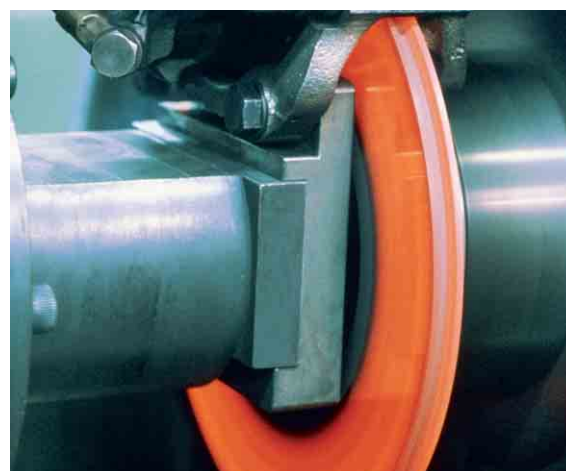
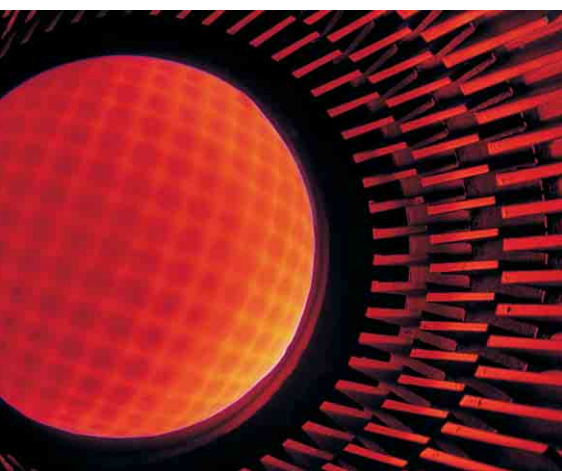

 **LEMO®**

Vacuumtest with  
leakdetector  
Vakuumtest mit  
Leakdetektor



Vacuumtight sealed  
sockets with  
Ni-Cr/Ni contacts  
Hochvakuumdichte  
Apparatedosen mit  
Ni-Cr/Ni-Kontakten



Crimping:  
coaxial, biaxial,  
triaxial, multipole  
Crimpen:  
koaxial, biaxial,  
triaxial, mehrpolig



Cable  
assembling  
and system  
technology  
Konfektionieren  
von Steckver-  
bindungen und  
Systemtechnologie



Cable overmold  
technology  
Umspritzen für  
Kabelzug-  
entlastungen

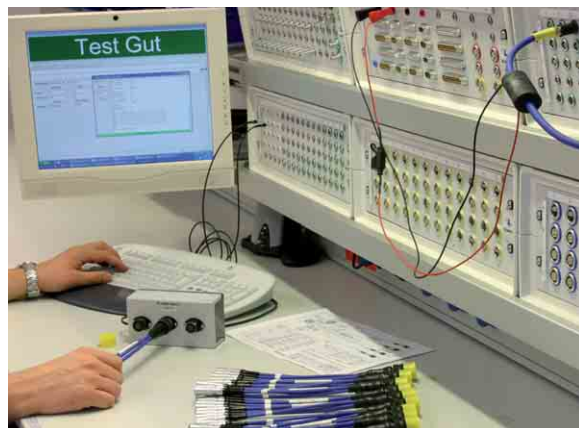

Final inspection  
completely  
PC-organized  
Endkontrolle  
komplett  
PC-organisiert

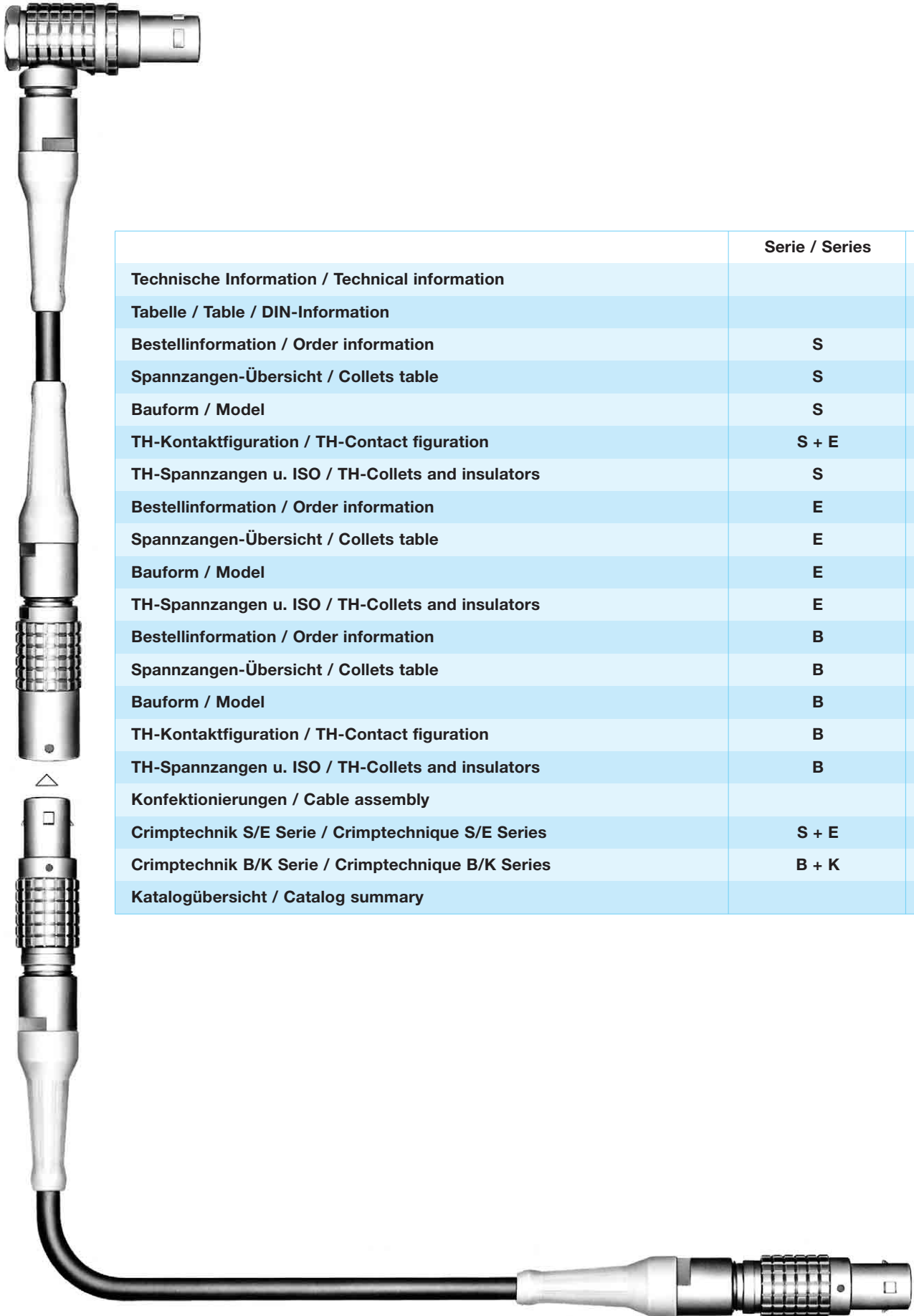

	Serie / Series	Seite / Page
Technische Information / Technical information		4 – 7
Tabelle / Table / DIN-Information		8 – 9
Bestellinformation / Order information	S	10
Spannzangen-Übersicht / Collets table	S	11 – 13
Bauform / Model	S	14 – 17
TH-Kontaktfiguration / TH-Contact figuration	S + E	18
TH-Spannzangen u. ISO / TH-Collets and insulators	S	19 – 25
Bestellinformation / Order information	E	26
Spannzangen-Übersicht / Collets table	E	27
Bauform / Model	E	28 – 30
TH-Spannzangen u. ISO / TH-Collets and insulators	E	31
Bestellinformation / Order information	B	32
Spannzangen-Übersicht / Collets table	B	33
Bauform / Model	B	34 – 36
TH-Kontaktfiguration / TH-Contact figuration	B	37
TH-Spannzangen u. ISO / TH-Collets and insulators	B	38 – 40
Konfektionierungen / Cable assembly		41
Crimptechnik S/E Serie / Crimp technique S/E Series	S + E	42 – 46
Crimptechnik B/K Serie / Crimp technique B/K Series	B + K	47 – 50
Katalogübersicht / Catalog summary		51

Messwiderstände, Widerstandsthermometer, Ausgleichsleitungen, Mantel-Thermoelemente müssen für den industriellen Einsatz mit einer geeigneten Steckverbindung versehen werden.

Das Messen der Thermospannung erfolgt in mV und  $\mu$ V. Für diesen Messbereich ist die LEMO-Steckverbindung das ideale Bauteil.

Measure resistances, resistance thermometers, compensation cables, insulated cables and particularly insulated thermocouples must be fitted with a suitable connector for the industrial use.

The thermovoltage is measured in mV and  $\mu$ V. The LEMO connector is the ideal construction part for this technology.

### Mantel-Thermoelemente, Aufbau und Funktion

Miniatur-Mantel-Thermoelemente bestehen aus einem Thermopaar, eingebettet in einer hochtemperaturfesten keramischen Isolationsschicht, umgeben von einem Metallmantel, der als Schutz gegen mechanische und chemische Einwirkungen dient.

### Jacket thermocouples, construction and function

Miniature jacket thermocouples consist of a thermo pair fitted in an high temperature ceramic insulation material coated with a metallic jacket, saved against mechanical and chemical effects.

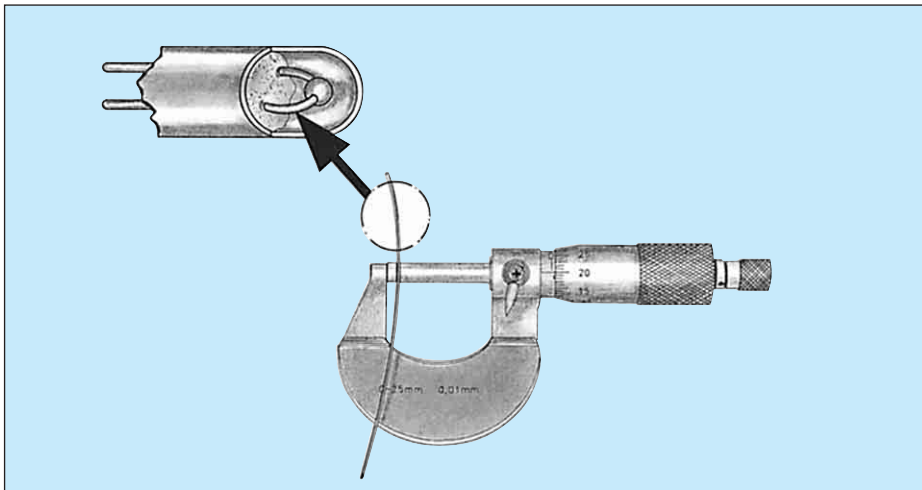

Der Aufbau und die Funktion von Mantel-Thermoelementen ist bis hin zu Steckverbindungen in der DIN 4370, 43721, I.E.C.584 1, 2 und 4, festgehalten.

The construction and the function of the thermocouples and the parts of the connector are normed in DIN 4370, 43721, I.E.C.584 1, 2 and 4.



Die Auswahl des Adermaterials bestimmt den Temperaturbereich.

Mit TH-Thermoelementen sind Messungen zwischen - 250 und + 2200 °C möglich. Die Entwicklung für neue Werkstoffe, seit der Einführung durch SEEBECK und PELTIER, ist noch immer in Bewegung.

Das gebräuchlichste Thermopaar ist die Ausführung Chromel-Alumel (Typ K). Der Einsatzbereich liegt bei - 200 bis 1100 °C. In Verbindung mit unserer LEMO Steckverbindung erhält man hier gute thermoelektrische Eigenschaften, und der Thermo-Spannungsverlauf ist fast linear.

The part of the wire material will be chosen for the temperature range.

The measurements of thermocouples are between - 250 and + 2200 °C. The development of new materials is still moving since the introduction of SEEBECK and PELTIER.

The most used thermocouple is the part of Chromel-Alumel (type K). The temperature range is from - 200 to 1100 °C. With our LEMO connector we reached good thermoelectric characteristics. The thermoelectric power curve is nearly linear.

**Thermospannung (mV)**

**Thermoelectric power (mV)**

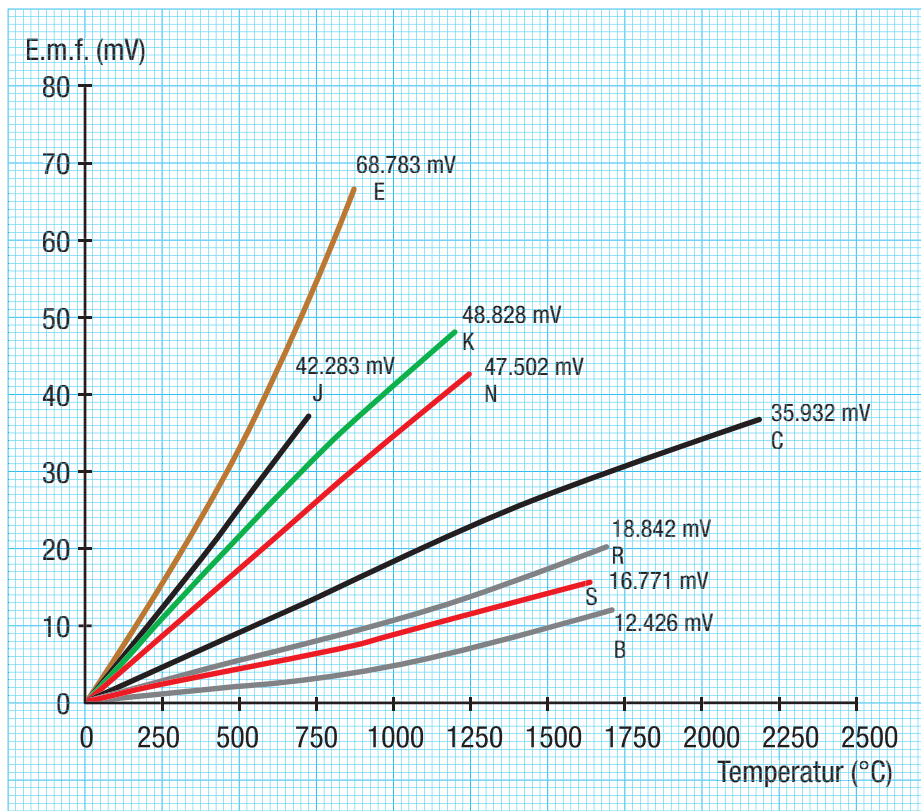

**Steckverbindung und Thermoelement**

Die Entfernung zwischen der Meßstelle und dem Messgerät beträgt in extremen Fällen mehrere 100 m.

**Connector and thermocouple**

In extreme cases the distance between the measuring point and the gauge can be several hundred meters.

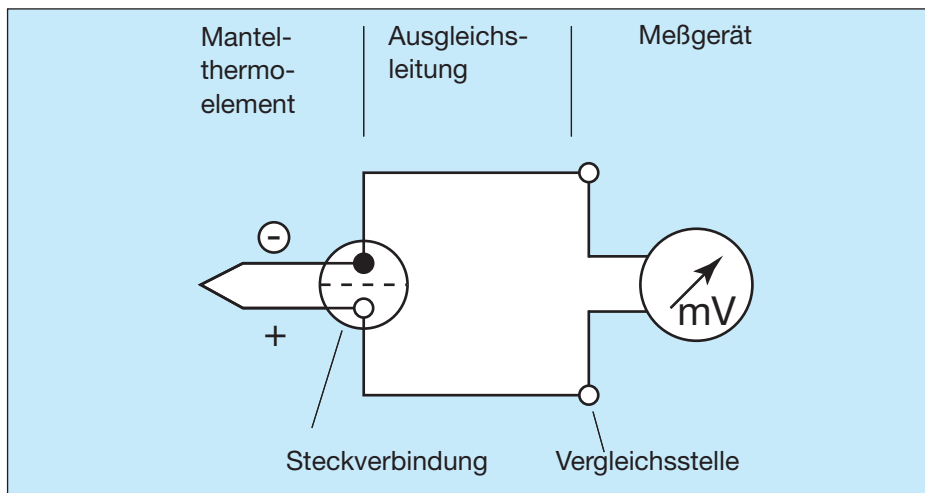
**Messaufbau**
**Measurement assembly**

Um eine einwandfreie Funktion der Miniatur-Mantel-Thermoelemente zu gewährleisten, müssen die Anschlußstellen gegen Feuchtigkeit dicht abgeschlossen werden. Dies geschieht durch Vergießen mit Kunststoffen. Hier hat sich insbesondere das Vergußmaterial STYCAST mit einem Temperaturbereich von 73 bis 177 °C, bewährt.

To guarantee a good function of the insulated miniature thermocouples, the connection points must be tightly sealed against humidity. This sealing can be made with plastic materials, especially STYCAST which has a temperature variation from 73 to 177 °C.

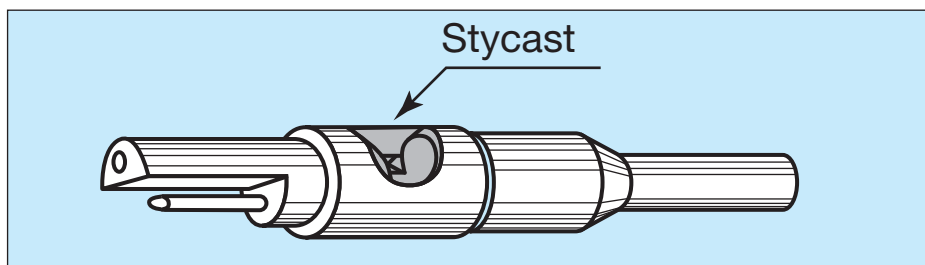
**TH-Spannzangen mit Vergußstelle**
**TH-collets with sealing point**

Aus langen Erfahrungswerten geht hervor, daß bei den gebräuchlichsten Thermopaaren, wie z. B. Chromel-Alumel, die hochwertigen LEMO-Kontakte in der speziell vergoldeten Version eingesetzt werden können. An der Anschlußstelle mit dem Thermoelementmaterial hebt sich die EMK (elektromagnetische Kraft) vollständig auf. Dies ist aber nur der Fall, wenn die Steckverbindung als Zwischenstück in der Thermoleitung dient und diese sich wiederum auf einem gleichbleibenden Temperaturlevel befindet. Überall dort, wo ein thermisches Gleichgewicht der Steckverbindung nicht erreicht wird, muß der Steckkontakt aus demselben Material, wie das der Thermoelemente, gewählt werden. Siehe Tabelle Thermoelemente-Ausgleichskabel.

Bei der Verwendung von Steckverbindungen mit Thermokontakten ist auf den richtigen Anschluß nach DIN 43711, A.N.S.I. MC 96.1, zu achten.

**Siehe Tabelle nach Farbcode und +/- Einteilung.**

**Wir empfehlen nachstehendes Lötzinn:**

Bei der Verwendung von Lötzinn, Typ HMP07, und der richtigen Löttemperatur (380 °C), ist eine leichte Verarbeitung und ein homogener Anschluß gewährleistet. Entspricht laut Freistellung der ISO 14001.

Das Mantel-Thermoelement wird in der Regel an der Kupplung, Typ PCA. . . . , oder an der Apparatedose mit Zugentlastung, Typ PSA. . . . , angeschlossen.

Der Anschluß der Ausgleichsleitung erfolgt somit am Slecker mit der Push-Pull-Verriegelung, Typ FFA. . . .

During many years of experience, we can assert that LEMO contacts of high quality in the special golden version can be mounted on the most used thermocouples, for example Chromel-Alumel. At the connection point with the thermocouple material neutralizes the e.m.f. (electromagnetic force). This is only the case, when the connector like an intermediate piece in the thermoelectric wire works. The system must be on a constant temperature level. Wherever we don't reach a thermal balance of the connector, the contact should be from the same material as the thermocouple. See table thermoelement compensation cable.

If you use connectors with thermocouples, you must pay attention to the assembly according to DIN 43711, A.N.S.I. MC 96.1.











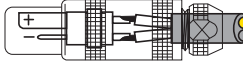
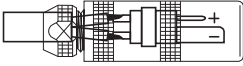
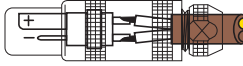

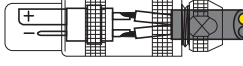



**See following table code colours and +/- splitting.**

**We recommend following solder tin:**

When you work with solder tin of type HMP07 and the right soldering temperature (380 °C), an easy working and a homogeneous connection can be guaranteed. According to release of ISO 14001.

The jacket thermocouple will be usually connected to the free socket of type PCA. . . . or to the receptacle with cable collet type PSA. . . .





































The compensation cable is consequently fitted at the connector with Push-Pull locking system, type FFA. . . .

Thermoelement			Ausgleichskabel	
Typ/Model	Polung / Pole	Material	Polung / Pole	Material
B		+ Platin, 30% Rodium – Platin, 6% Rodium		+ Cu-Legierung – Cu
E		+ Nickel-Chrom (Chromel) – Kupfer-Nickel (Konstantan)		+ NiCr – CuNi
J		+ Eisen – Kupfer-Nickel (Konstantan)		+ Fe – CuNi
K		+ Nickel-Chrom (Chromel) – Nickel (Alumel)		+ NiCr + Fe – Ni – CuNi
L		+ Eisen – Kupfer-Nickel (Konstantan)		+ Fe – CuNi
N		+ Nickel-Chrom-Silizium (Nicrosil) – Nickel-Silizium (Nisil)		+ NiCrSi + Cu – NiSi – CuNi
R		+ Platin, 13% Rodium – Platin		+ Cu – CuNi
S		+ Platin, 10% Rodium – Platin		+ Cu – CuNi
T		+ Kupfer – Kupfer-Nickel (Konstantan)		+ Cu – CuNi
U		+ Kupfer – Kupfer-Nickel (Konstantan)		+ Cu – CuNi



**Die gebräuchlichsten Aus-  
gleichskabel** (vor Dezember 1993)

**The common compensation  
cables** (before december 1993)

Typ Model	Standards	Mantel (Sheath)	Seele + (Wire +)	Seele - (Wire -)
K	NF			
K	DIN			
K	BS			
K	ANSI			
J	NF			
L	DIN			
J	BS			
J	ANSI			
E	NF			
T	NF			
T	DIN			
S	NF			

Ab Dezember 1993 sind die unterschiedlichen Normen, NF C 42-324, DIN 43714 (ausgenommen Typ L) BS 1843 und ANSI MC 96.1 in den internationalen Standards IEC 584-3 und der DIN 43722 zusammengefasst.

Different norms as NF C 42-324, DIN 43714 (except type no. L), BS 1843 and ANSI MC 96.1 are summarised in the international standard IEC 584-3 and DIN 43722 since December 1993.

Typ Model	Standards	Mantel (Sheath)	Seele + (Wire +)	Seele - (Wire -)
K	IEC 584-3 DIN 43722			
J	IEC 584-3 DIN 43722			
E	IEC 584-3 DIN 43722			
T	IEC 584-3 DIN 43722			
S	IEC 584-3 DIN 43722			

**Konstruktions-Information**  
**S Serie Standard**

**Constructions information**  
**S Series standard**

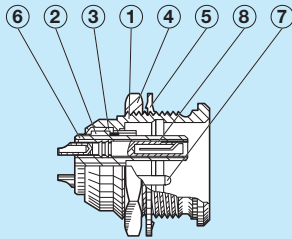

**Fixed socket**

- ① Outer shell
- ② Earthing crown
- ③ Retaining ring
- ④ Hexagonal nut
- ⑤ Locking washer
- ⑥ Insulator
- ⑦ Male contact
- ⑧ Female contact

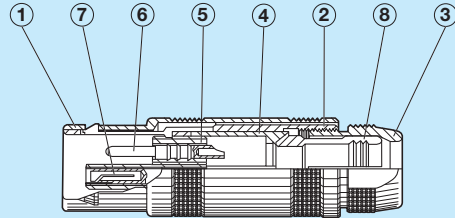

**Straight plug**

- ① Outer shell
- ② Latch sleeve
- ③ Collet nut
- ④ Centre-piece
- ⑤ Insulator
- ⑥ Male contact
- ⑦ Female contact
- ⑧ Collet

**Bestellbeispiele**

**Part number example**

**Standardstecker, gerade**

**Straight standard plug**

FFA OS 302 C L A L 32 Z N

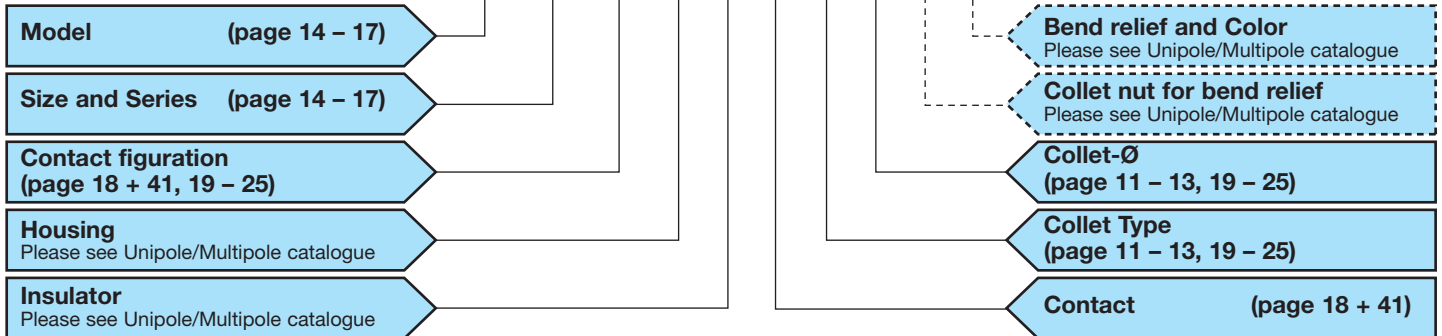

Standardstecker gerade, Größe 0, S Serie  
 mehrpolig (2 Kontakte), Außenkörper aus  
 Messing, Isolationsstück aus PEEK, männlicher  
 und weiblicher Lötkontakt, Spannzange für  
 geschirmtes Kabel, Durchmesser 3,2 mm.

Straight plug, size 0, S Series, 2 contacts,  
 chromed brass shell, PEEK insulator, male and  
 female solder contact, collet 3,2 mm for shielded  
 cable.

**Apparatedose**

**Socket**

ERA 2S 302 C L L

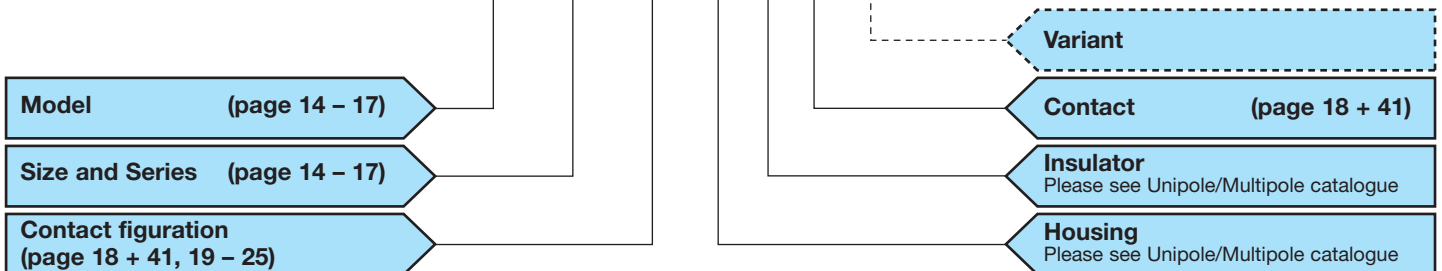

Einbauapparatedose, Größe 2, S Serie, mehr-  
 polig (2 Kontakte), Außenkörper aus Messing,  
 verchromt, Massekrone vernickelt, Isolationsstück  
 aus PEEK, männlicher und weiblicher Lötkontakt.

Fixed socket, size 2, S Series, 2 contacts, chro-  
 med brass shell, PEEK insulator, female and  
 male solder contact.

**S Series - Size 0**  
**S Serie - Größe 0**

Reference		C = AG				L = NG		K = Adapter to the next size	
		Ø Collet (mm)		Ø Cable (mm)		Part number collet <sup>1)</sup>	Re- marks	Part number adapter <sup>2)</sup>	Part number Collet nut <sup>2)</sup>
Model	Ø	ØA	ØB	max.	min.				
C	17	1,7	—	1,6	1,3	FFA.0S.717.CN	○		
C	22	2,2	—	2,1	1,7	FFA.0S.722.CN	○		
C	27	2,7	—	2,6	2,2	FFA.0S.727.CN	●		
C	32	3,2	—	3,1	2,7	FFA.0S.732.CN	●		
C	37	3,7	3,2	3,6	3,0	FFA.0S.737.CN	●		
C	42	4,2	3,7	4,1	3,3	FFA.0S.742.CN	●		
C	44	4,4	3,7	4,3	3,5	FFA.0S.744.CN	● <sup>4)</sup>		FFA.0S.133.LC
C	50	5,1	5,1	5,0	4,4	FFA.0S.750.CN	● <sup>4)</sup>		FFA.0S.133.LC
K	47	4,7	—	4,6	3,8	FFA.1S.747.CN	●	FFA.0S.137.LCN	FFA.1S.130.LC
K	52	5,2	—	5,1	4,3	FFA.1S.752.CN	●	FFA.0S.137.LCN	FFA.1S.130.LC
K	57	5,7	—	5,6	4,8	FFA.1S.757.CN	●	FFA.0S.137.LCN	FFA.1S.130.LC
K	62	6,2	5,2	6,1	5,3	FFA.1S.762.CN	●	FFA.0S.137.LCN	FFA.1S.130.LC
K	66	6,6	5,5	6,5	5,9	FFA.1S.766.CN	○	FFA.0S.137.LCN	FFA.1S.130.LC
K	68	6,8	5,5	6,7	6,0	FFA.1S.768.CN	●	FFA.0S.137.LCN	FFA.1S.130.LC
C	17	1,7	—	1,6	1,3	FLA.0S.717.CN	● <sup>3)</sup>		
C	22	2,2	—	2,1	1,7	FLA.0S.722.CN	● <sup>3)</sup>		
C	27	2,7	—	2,6	2,2	FLA.0S.727.CN	● <sup>3)</sup>		
C	32	3,2	—	3,1	2,7	FLA.0S.732.CN	● <sup>3)</sup>		
C	37	3,7	3,2	3,6	3,0	FLA.0S.737.CN	● <sup>3)</sup>		
C	42	4,2	3,7	4,1	3,3	FLA.0S.742.CN	● <sup>3)</sup>		
C	44	4,4	3,7	4,3	3,5	FLA.0S.744.CN	● <sup>3)</sup>		
L	17	1,7	—	1,6	1,3	FFA.0S.717.LN	●		
L	22	2,2	—	2,1	1,8	FFA.0S.722.LN	●		
L	27	2,7	—	2,6	2,3	FFA.0S.727.LN	●		
L	32	3,2	—	3,1	2,8	FFA.0S.732.LN	●		
L	37	3,7	—	3,6	3,0	FFA.0S.737.LN	●		
L	42	4,2	—	4,1	3,3	FFA.0S.742.LN	●		
L	48	4,8	—	4,7	4,4	FFA.0S.748.LN	● <sup>4)</sup>		FFA.0S.133.LC

<sup>1)</sup> Für Einzelbestellung der Spannzangen.

<sup>2)</sup> Für Einzelbestellung einer Spannzange der Type K benötigt man je einen Adapter und eine Spannschraube (Bestell-Nr. siehe oben).

<sup>3)</sup> Diese Spannzange paßt zu den Typen FLA, FFP und PCP.

<sup>4)</sup> Diese Spannzangen können nicht in Bauformen mit Spannschrauben für Knickschutztüllen verwendet werden.

<sup>1)</sup> For individual orders of collets.

<sup>2)</sup> For individual orders of a collet type K an adapter each is required as well as a collet nut (part number is mentioned above).

<sup>3)</sup> This collet is used for the FLA, FFP and PCP models.

<sup>4)</sup> These collets cannot be used for connector models with nut for fitting a bend relief.

● lieferbar  
○ auf Anfrage

● in stock  
○ on request

S Series – Size 1

S Serie – Größe 1

Reference		C = AG				L = NG		K = Adapter to the next size		
		Ø Collet (mm)		Ø Cable (mm)		Part number collet 1)	Re- marks	Part number adapter 2)	Part number Collet nut 2)	
Model	Ø	Series	ØA	ØB	max.					min.
C	17	1S	1,7	—	1,6	1,3	FFA.1S.717.CN	○		FFA.1S.130.LC
C	22		2,2	—	2,1	1,7	FFA.1S.722.CN	●		FFA.1S.130.LC
C	27		2,7	—	2,6	2,2	FFA.1S.727.CN	●		FFA.1S.130.LC
C	32		3,2	—	3,1	2,6	FFA.1S.732.CN	●		FFA.1S.130.LC
C	37		3,7	—	3,6	2,7	FFA.1S.737.CN	●		FFA.1S.130.LC
C	42		4,2	—	4,1	3,3	FFA.1S.742.CN	●		FFA.1S.130.LC
C	47		4,7	—	4,6	3,8	FFA.1S.747.CN	●		FFA.1S.130.LC
C	52		5,2	—	5,1	4,3	FFA.1S.752.CN	●		FFA.1S.130.LC
C	57		5,7	—	5,6	4,8	FFA.1S.757.CN	●		FFA.1S.130.LC
C	62		6,2	5,2	6,1	5,3	FFA.1S.762.CN	●		FFA.1S.130.LC
C	66		6,6	5,5	6,5	5,9	FFA.1S.766.CN	● <sup>4)</sup>		FFA.1S.131.LC
C	68		6,8	5,5	6,7	6,0	FFA.1S.768.CN	● <sup>4)</sup>		FFA.1S.131.LC
K	72		7,2	6,7	7,0	6,1	FFA.2S.772.CN	●	FFA.1S.137.LCN	FFA.2S.130.LC
K	77		7,7	6,7	7,5	7,1	FFA.2S.777.CN	○	FFA.1S.137.LCN	FFA.2S.130.LC
K	82		8,2	6,7	8,0	7,6	FFA.2S.782.CN	○	FFA.1S.137.LCN	FFA.2S.130.LC
K	87		8,7	6,7	8,5	8,1	FFA.2S.787.CN	○	FFA.1S.137.LCN	FFA.2S.130.LC
C	17		1,7	—	1,6	1,3	FLA.1S.717.CN	● <sup>3)</sup>		FFA.1S.130.LC
C	22		2,2	—	2,1	1,7	FLA.1S.722.CN	● <sup>3)</sup>		FFA.1S.130.LC
C	27		2,7	—	2,6	2,2	FLA.1S.727.CN	● <sup>3)</sup>		FFA.1S.130.LC
C	32		3,2	—	3,1	2,6	FLA.1S.732.CN	● <sup>3)</sup>		FFA.1S.130.LC
C	37		3,7	—	3,6	2,7	FLA.1S.737.CN	● <sup>3)</sup>		FFA.1S.130.LC
C	42		4,2	—	4,1	3,3	FLA.1S.742.CN	● <sup>3)</sup>		FFA.1S.130.LC
C	47		4,7	—	4,6	3,8	FLA.1S.747.CN	● <sup>3)</sup>		FFA.1S.130.LC
C	52		5,2	—	5,1	4,3	FLA.1S.752.CN	● <sup>3)</sup>		FFA.1S.130.LC
C	57		5,7	—	5,6	4,8	FLA.1S.757.CN	● <sup>3)</sup>		FFA.1S.130.LC
C	62		6,2	5,2	6,1	5,3	FLA.1S.762.CN	● <sup>3)</sup>		FFA.1S.130.LC
C	66		6,6	5,5	6,5	5,9	FLA.1S.766.CN	● <sup>3)</sup>		FFA.1S.131.LC
C	68		6,8	5,5	6,7	6,0	FLA.1S.768.CN	● <sup>3)</sup>		FFA.1S.131.LC
L	17	1,7	—	1,6	1,3	FFA.1S.717.LN	●		FFA.1S.130.LC	
L	22	2,2	—	2,1	1,7	FFA.1S.722.LN	●		FFA.1S.130.LC	
L	27	2,7	—	2,6	2,2	FFA.1S.727.LN	●		FFA.1S.130.LC	
L	32	3,2	—	3,1	2,6	FFA.1S.732.LN	●		FFA.1S.130.LC	
L	37	3,7	—	3,6	2,7	FFA.1S.737.LN	●		FFA.1S.130.LC	
L	42	4,2	—	4,1	3,3	FFA.1S.742.LN	●		FFA.1S.130.LC	
L	47	4,7	—	4,6	3,8	FFA.1S.747.LN	●		FFA.1S.130.LC	
L	50	5,0	—	4,9	4,7	FFA.1S.750.LN	●		FFA.1S.130.LC	
L	52	5,2	—	5,1	4,3	FFA.1S.752.LN	●		FFA.1S.130.LC	
L	57	5,7	—	5,6	4,8	FFA.1S.757.LN	●		FFA.1S.130.LC	
L	62	6,2	—	6,1	5,3	FFA.1S.762.LN	●		FFA.1S.130.LC	
L	66	6,6	—	6,5	5,9	FFA.1S.766.LN	● <sup>4)</sup>		FFA.1S.131.LC	

1) Für Einzelbestellung der Spannzangen.

2) Für Einzelbestellung einer Spannzange der Type K benötigt man je einen Adapter und eine Spannschraube (Bestell-Nr. siehe oben).

3) Diese Spannzange paßt zu Type FLA.

4) Diese Spannzangen können nicht in Bauformen mit Spannschrauben für Knickschutztüllen verwendet werden.

1) For individual orders of collets.

2) For individual orders of a collet type K an adapter each is required as well as a collet nut (part number is mentioned above).

3) This collet is used for the FLA models.

4) These collets cannot be used for connector models with nut for fitting a bend relief.

● lieferbar  
○ auf Anfrage● in stock  
○ on request

**S Series - Size 2**  
**S Serie - Größe 2**

Reference		C = AG				L = NG		K = Adapter to the next size	
		Ø Collet (mm)		Ø Cable (mm)		Part number collet <sup>1)</sup>	Re-remarks	Part number adapter <sup>2)</sup>	Part number Collet nut <sup>2)</sup>
Model	Ø	ØA	ØB	max.	min.				
C	17	1,7	-	1,5	1,3	FFA.2S.717.CN	○		FFA.2S.130.LC
C	27	2,7	-	2,5	1,7	FFA.2S.727.CN	○		FFA.2S.130.LC
C	32	3,2	-	3,0	2,5	FFA.2S.732.CN	○		FFA.2S.130.LC
C	42	4,2	-	4,0	3,1	FFA.2S.742.CN	●		FFA.2S.130.LC
C	52	5,2	-	5,0	4,1	FFA.2S.752.CN	●		FFA.2S.130.LC
C	62	6,2	-	6,0	5,1	FFA.2S.762.CN	●		FFA.2S.130.LC
C	72	7,2	6,7	7,0	6,1	FFA.2S.772.CN	●		FFA.2S.130.LC
C	77	7,7	6,7	7,5	7,1	FFA.2S.777.CN	●		FFA.2S.130.LC
C	82	8,2	6,7	8,0	7,6	FFA.2S.782.CN	○		FFA.2S.130.LC
C	87	8,7	6,7	8,5	8,1	FFA.2S.787.CN	○		FFA.2S.130.LC
K	92	9,2	8,7	9,0	8,1	FFA.3S.792.CN	●	FFA.2S.137.LCN	FFA.3S.130.LC
K	97	9,7	8,7	9,5	9,1	FFA.3S.797.CN	●	FFA.2S.137.LCN	FFA.3S.130.LC
K	10	10,2	8,7	10,0	9,6	FFA.3S.710.CN	●	FFA.2S.137.LCN	FFA.3S.130.LC
K	11	10,7	8,7	10,5	10,1	FFA.3S.711.CN	●	FFA.2S.137.LCN	FFA.3S.130.LC
C	17	1,7	-	1,5	1,3	FLA.2S.717.CN	● <sup>3)</sup>		FFA.2S.130.LC
C	27	2,7	-	2,5	1,7	FLA.2S.727.CN	● <sup>3)</sup>		FFA.2S.130.LC
C	32	3,2	-	3,0	2,5	FLA.2S.732.CN	● <sup>3)</sup>		FFA.2S.130.LC
C	42	4,2	-	4,0	3,1	FLA.2S.742.CN	● <sup>3)</sup>		FFA.2S.130.LC
C	52	5,2	-	5,0	4,1	FLA.2S.752.CN	● <sup>3)</sup>		FFA.2S.130.LC
C	62	6,2	-	6,0	5,1	FLA.2S.762.CN	● <sup>3)</sup>		FFA.2S.130.LC
C	72	7,2	6,7	7,0	6,1	FLA.2S.772.CN	● <sup>3)</sup>		FFA.2S.130.LC
C	77	7,7	6,7	7,5	7,1	FLA.2S.777.CN	● <sup>3)</sup>		FFA.2S.130.LC
L	82	8,2	6,7	8,0	7,6	FLA.2S.782.CN	● <sup>3)</sup>		FFA.2S.130.LC
L	87	8,7	6,7	8,5	8,1	FLA.2S.787.CN	● <sup>3)</sup>		FFA.2S.130.LC
L	27	2,7	-	2,5	1,7	FFA.2S.727.LN	●		FFA.2S.130.LC
L	32	3,2	-	3,0	2,5	FFA.2S.732.LN	●		FFA.2S.130.LC
L	42	4,2	-	4,0	3,1	FFA.2S.742.LN	●		FFA.2S.130.LC
L	52	5,2	-	5,0	4,1	FFA.2S.752.LN	●		FFA.2S.130.LC
L	62	6,2	-	6,0	5,1	FFA.2S.762.LN	●		FFA.2S.130.LC
L	72	7,2	-	7,0	6,1	FFA.2S.772.LN	●		FFA.2S.130.LC
L	77	7,9	-	7,5	7,1	FFA.2S.777.LN	●		FFA.2S.130.LC
L	82	8,2	6,7	8,0	7,6	FFA.2S.782.LN	●		FFA.2S.130.LC
L	87	8,7	-	8,5	7,8	FFA.2S.787.LN	●		FFA.2S.130.LC

<sup>1)</sup> Für Einzelbestellung der Spannzangen.

<sup>2)</sup> Für Einzelbestellung einer Spannzange der Type K benötigt man je einen Adapter und eine Spannschraube (Bestell-Nr. siehe oben).

<sup>3)</sup> Diese Spannzange paßt zu Type FLA.

<sup>1)</sup> For individual orders of collets.

<sup>2)</sup> For individual orders of a collet type K an adapter each is required as well as a collet nut (part number is mentioned above).

<sup>3)</sup> This collet is used for the FLA models.

● lieferbar  
○ auf Anfrage

● in stock  
○ on request

S Series – standard

S Serie – Standard

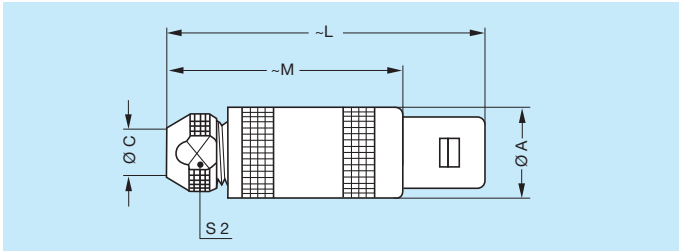
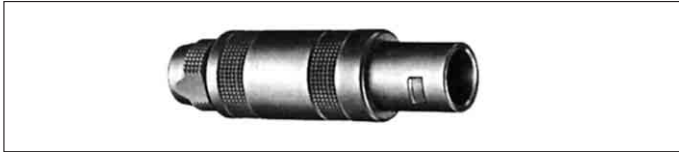

### Standard plug Standardstecker

Reference		Dimensions (mm)				
Model	Series	A	C	L	M	S2
FFA	0S	9.0	4.2	34.5	24.5	6.5
FFA	1S	12.0	6.2	42.5	31.5	8.5
FFA	2S	14.8	8.5	52.0	40.0	11.0

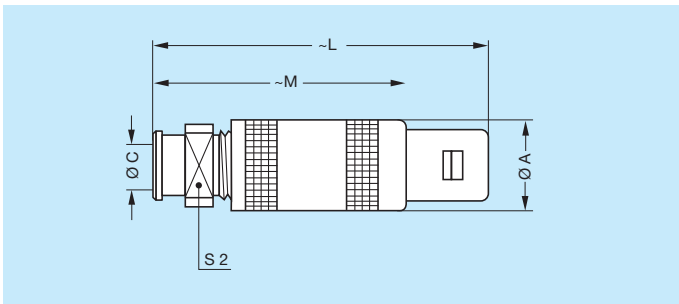

### Standard plug with cable collet and nut for fitting a strain relief Standardstecker mit Knickschutzschraube

Reference		Dimensions (mm)				
Model	Series	A	C	L	M	S2
FFA	0S	9.0	4.2	36.5	26.5	7
FFA	1S	12.0	6.2	45.0	34.0	9
FFA	2S	14.8	8.5	54.5	42.5	12

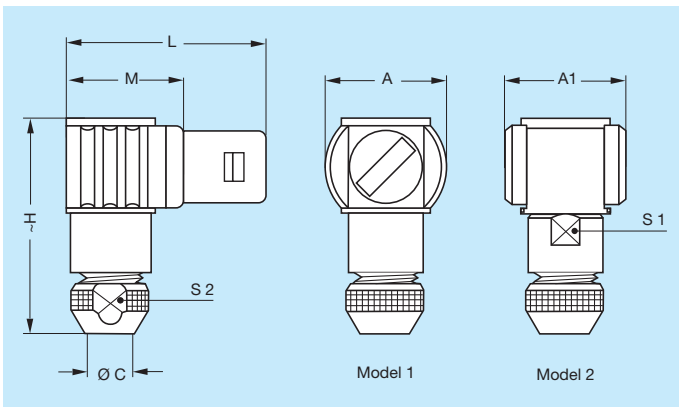

### Elbow plug (90°) Winkelstecker (90°)

Reference		Dimensions (mm)							
Model	Series	A	A1	C	H	L	M	S1	S2
FLA	0S	13	13	4.2	24.5	23.0	13.0	8	6.5
FLA	1S	16	16	6.2	28.5	26.5	15.5	10	8.5
FLA	2S	20	20	8.5	37.0	31.0	19.0	13	11.0

Model 1: for unipole and coaxial types  
Model 2: for all other types

Modell 1: für einpolige und koaxiale Typen  
Modell 2: für alle anderen Typen





**Plug with visible shell, non latching  
Positive Apparatedose (Einbaustecker)**

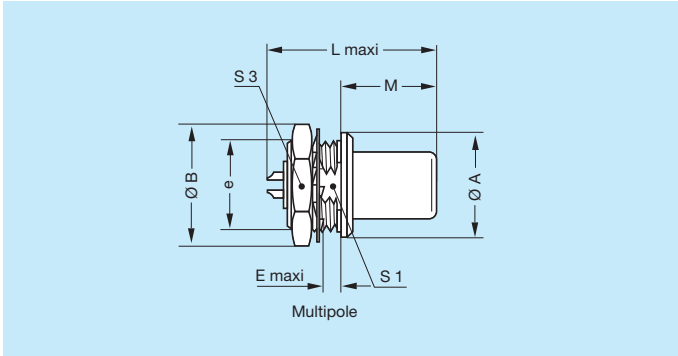

Reference		Dimensions (mm)								
Model	Series	A	B	e	E	L	M	S1	S3	
FAA	0S	10	12.5	M9 x 0.6	2.0	18.5	11.2	8.2	11	
FAA	1S	14	16.0	M12 x 1	2.5	22.5	12.5	10.5	14	
FAA	2S	18	19.5	M15 x 1	4.0	25.0	13.8	13.5	17	



**Fixed socket  
Einbauapparatedose**

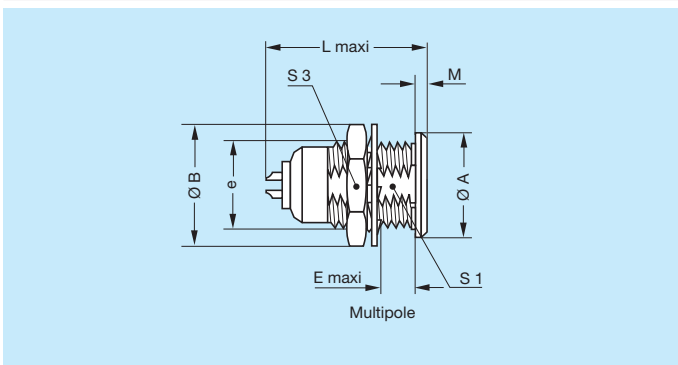

Reference		Dimensions (mm)								
Model	Series	A	B	e	E	L	M	S1	S3	
ERA	0S	10	12.5	M9 x 0.6	7.0	17.5	1.2	8.2	11	
ERA	1S	14	16.0	M12 x 1	7.5	21.5	1.5	10.5	14	
ERA	2S	18	19.5	M15 x 1	8.5	24.0	1.8	13.5	17	



**Fixed socket with two fixing nuts  
(back panel mounting)  
Einbauapparatedose mit durchgehendem  
Gewinde, Flanschschraube an der Frontplatte  
und Sechskantschraube**

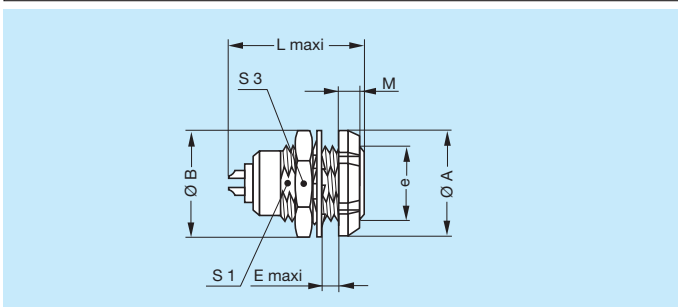

Reference		Dimensions (mm)								
Model	Series	A	B	e	E	L	M	S1	S3	
ERD	0S	12	12.5	M9 x 0.6	5.5	17.5	2.5	8.2	11	
ERD	1S	16	16.0	M12 x 1	6.0	21.5	3.2	10.5	14	
ERD	2S	20	19.5	M15 x 1	6.0	24.0	3.8	13.5	17	

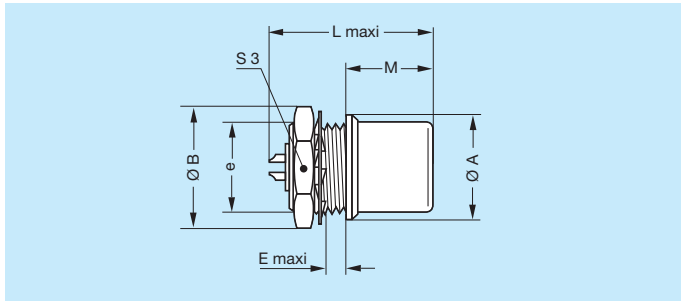

**Fixed socket with visible shell**  
**Einbauapparatdose mit vorstehendem Körper**

Reference		Dimensions (mm)						
Model	Series	A	B	e	E	L	M	S3
EHP	0S	10	12.5	M9 x 0.6	2.5	17.5	12.5	11
EHP	1S	14	16.0	M12 x 1	2.0	21.5	12.0	14

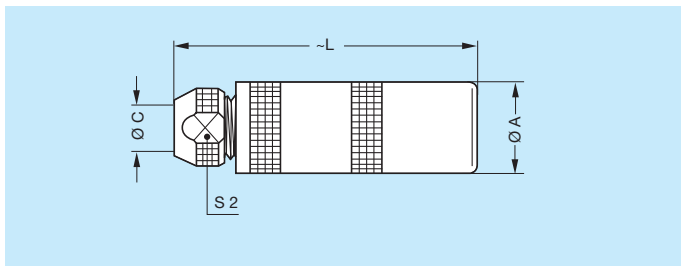
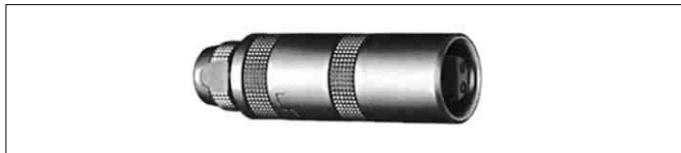

**Free socket**  
**Kabelkupplung**

Reference		Dimensions (mm)			
Model	Series	A	C	L	S2
PCA	0S	8.9	4.2	33.5	6.5
PCA	1S	11.9	6.2	40.5	8.5
PCA	2S	14.8	8.5	50.0	11.0

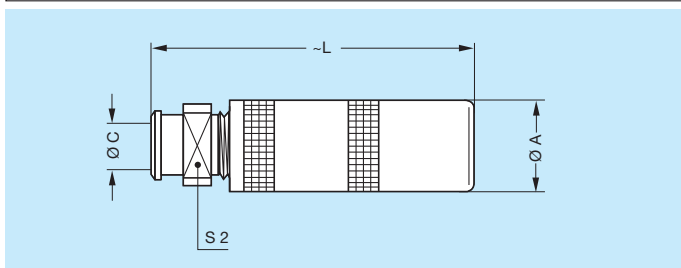
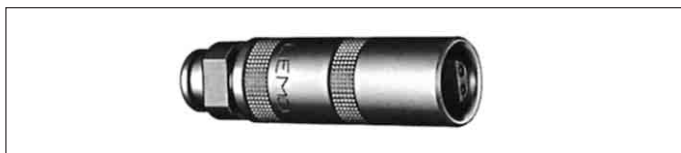

**Free socket with collet for a strain relief**  
**Kabelkupplung mit Knickschutzschraube**

Reference		Dimensions (mm)			
Model	Series	A	C	L	S2
PCA	0S	8.9	4.2	35.0	7
PCA	1S	11.9	6.2	43.0	9
PCA	2S	14.8	8.5	52.5	12

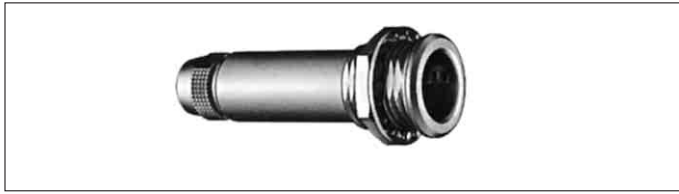

**Fixed socket with cable collet**  
**Einbauapparatdose mit Zugentlastung**

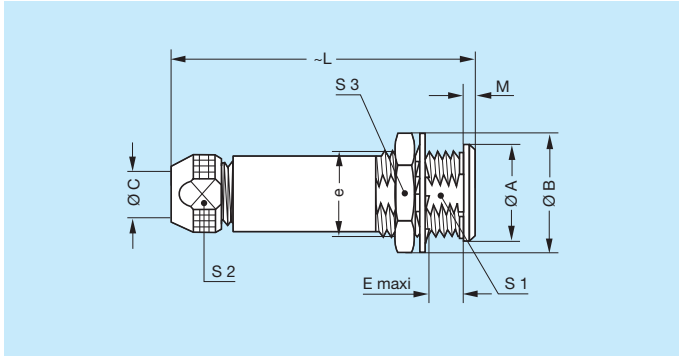



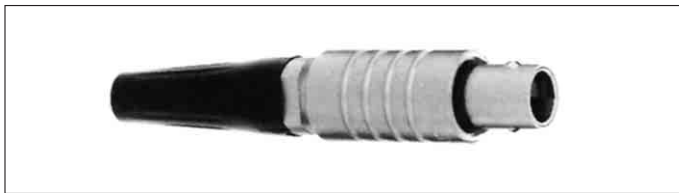



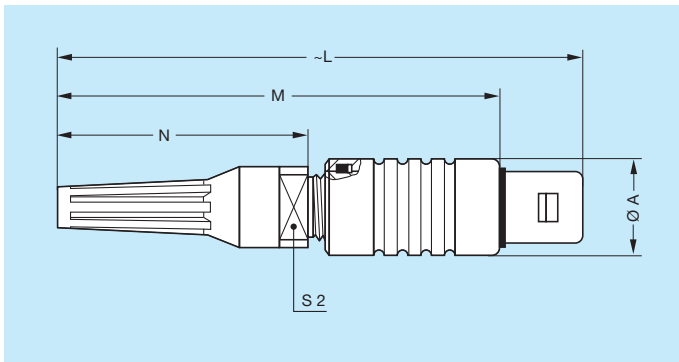















Reference		Dimensions (mm)									
Model	Series	A	B	C	e	E	L	M	S1	S2	S3
PSA	0S	10	12.5	4.2	M9 x 0.6	7.0	33.5	1.2	8.2	6.5	11
PSA	1S	14	16.0	6.2	M12 x 1	7.5	40.5	1.5	10.5	8.5	14
PSA	2S	18	19.5	8.5	M15 x 1	8.5	50.0	1.8	13.5	11.0	17



**Straight plug for IP 56**  
**Stecker, gerade, nach IP 56**



Reference		Dimensions (mm)				
Model	Series	A	L	M	N	S2
FFE	0S	10	55.5	45.5	26.0	7
FFE	1S	13	70.0	59.0	33.0	9
FFE	2S	16	84.0	72.0	40.5	12

TH-Insulator			Reference	Series	Number of contacts	Contacts-Ø Ø A (mm)	Max. Conductor-Ø	Contact-no.	Thermo contact-Type					
Size	FFA	ERA / PSA							E	J	K	T	L	W
0S 0E			302	0S	2	0.9	0.8	1 2	EN EP	JN JP	KN KP	TN TP	LN LP	W W
			303	0S	3	0.7	0.6	1 2 3	EP EN L	JP JN L	KP KN L	TP TN L	LP LN L	W W W
			902	0S	4	0.7	0.6	1-3 2-4	EP EN	JP JN	KP KN	TP TN	LP LN	W W
1S 1E			302	1S	2	1.3	1.0	1 2	EN EP	JN JP	KN KP	TN TP	LN LP	W W
			303	1S	3	0.9	0.8	1 2 3	EP EN L	JP JN L	KP KN L	TP TN L	LP LN L	W W W
			902	1S	4	0.9	0.8	1-3 2-4	EP EN	JP JN	KP KN	TP TN	LP LN	W W
			903	1S	6	0.7	0.6	1-3-5 2-4-6	EP EN	JP JN	KP KN	TP TN	LP LN	W W
2S 2E			302	2S	2	1.6	1.4	1 2	EN EP	JN JP	KN KP	TN TP	LN LP	W W
			303	2S	3	1.3	1.0	1 2 3	EP EN L	JP JN L	KP KN L	TP TN L	LP LN L	W W W
			902	2S	4	1.3	1.0	1-3 2-4	EP EN	JP JN	KP KN	TP TN	LP LN	W W
			903	2S	6	1.3	1.0	1-3-5 2-4-6	EP EN	JP JN	KP KN	TP TN	LP LN	W W

## Bestellbeispiel

Isolationsteile: FFA.0S.302.ZLK  
 PSA.0S.302.ZLK  
 Stecker: FFA.0S.302.CLK  
 Apparatedose: ERA.0S.302.CLK  
 Kupplung: PCA.0S.302.CLK

## Part number example

Insulator: FFA.0S.302.ZLK  
 PSA.0S.302.ZLK  
 Plug: FFA.0S.302.CLK  
 Fixed socket: ERA.0S.302.CLK  
 Free socket: PCA.0S.302.CLK

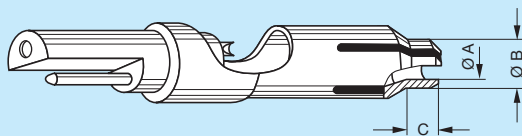

Part number Collet	Reference		Series	Dimensions of the collet (mm)			Ø Thermo-couple max. (mm)	Part number Insulator	Part number Collet/Insulator, fitted	Time of delivery	
	Model	Ø		ØA	ØB	C					
FFA.0S.703.FN	F	03	0S	0.3	4.0	2.8	0.27	2-polig: PSA.0S.302.ZLLZ	PSA.0S.30..ZLLF03	○	
FFA.0S.705.FN	F	05		0.5	4.0	2.8	0.45		PSA.0S.30..ZLLF05	○	
FFA.0S.707.FN	F	07		0.7	4.0	2.8	0.60		PSA.0S.30..ZLLF07	○	
FFA.0S.710.FN	F	10		1.0	4.0	2.8	0.90		3-polig: PSA.0S.303.ZLLZ	PSA.0S.30..ZLLF10	●
FFA.0S.712.FN	F	12		1.2	4.0	2.8	1.10			PSA.0S.30..ZLLF12	○
FFA.0S.715.FN	F	15		1.5	4.0	2.8	1.40			PSA.0S.30..ZLLF15	●
FFA.0S.717.FN	F	17		1.7	4.0	2.8	1.60			PSA.0S.30..ZLLF17	○
FFA.0S.720.FN	F	20		2.0	4.0	2.8	1.90	PSA.0S.30..ZLLF20		●	
FFA.0S.722.FN	F	22		2.2	4.0	2.8	2.10	PSA.0S.30..ZLLF22		○	
FFA.0S.725.FN	F	25		2.5	4.0	2.8	2.40	PSA.0S.30..ZLLF25		●	
FFA.0S.727.FN	F	27		2.7	4.0	2.8	2.60	PSA.0S.30..ZLLF27	○		
FFA.0S.730.FN	F	30		3.0	4.0	2.8	2.90	4-polig: PSA.0S.304.ZLLZ	PSA.0S.30..ZLLF30	●	
FFA.0S.734.FN	F	34		3.4	5.0	3.7	3.30		PSA.0S.30..ZLLF34	○	
FFA.0S.742.FN	F	42		4.2	5.0	3.7	4.10		PSA.0S.30..ZLLF42	○	
FFA.1S.717.FN	F	17	1S	1.7	5.0	5.2	1.60	2-polig: PSA.1S.302.ZLLZ	PSA.1S.30..ZLLF17	○	
FFA.1S.722.FN	F	22		2.2	5.0	5.2	2.10	3-polig: PSA.1S.303.ZLLZ	PSA.1S.30..ZLLF22	○	
FFA.1S.727.FN	F	27		2.7	5.0	5.2	2.60		PSA.1S.30..ZLLF27	○	
FFA.1S.734.FN	F	34		3.4	5.0	5.2	3.30		4-polig: PSA.1S.304.ZLLZ	PSA.1S.30..ZLLF34	○
FFA.1S.742.FN	F	42		4.2	6.0	5.2	4.10	PSA.1S.30..ZLLF42		○	
FFA.1S.752.FN	F	52		5.2	6.0	5.2	5.10	PSA.1S.30..ZLLF52		○	
FFA.1S.761.FN	F	61		6.1	6.7	5.2	6.00	PSA.1S.30..ZLLF67			
FFA.2S.722.FN	F	22	2S	2.2	6.0	7.5	2.10	2-polig: PSA.2S.302.ZLLZ	PSA.2S.30..ZLLF22		
FFA.2S.727.FN	F	27		2.7	6.0	7.5	2.60	3-polig: PSA.2S.303.ZLLZ	PSA.2S.30..ZLLF27	○	
FFA.2S.734.FN	F	34		3.4	6.0	7.5	3.30		PSA.2S.30..ZLLF34	○	
FFA.2S.742.FN	F	42		4.2	6.0	7.5	4.10	4-polig: PSA.2S.304.ZLLZ	PSA.2S.30..ZLLF42	○	
FFA.2S.752.FN	F	52		5.2	8.3	7.5	5.10		PSA.2S.30..ZLLF52	○	
FFA.2S.767.FN	F	67		6.7	8.3	7.5	6.60		PSA.2S.30..ZLLF67	○	

- auf Lager  
(Lieferzeit je nach Lagerbestand)
- Auftragsfertigung im Werk

Bestellbeispiel:  
PSA.0S.302.ZLLF03

- in stock  
(delivery time depends of stock)
- order in production

Part number example:  
PSA.0S.302.ZLLF03

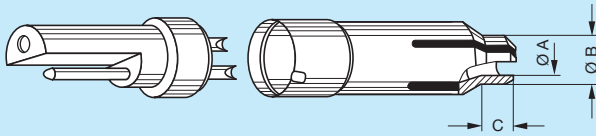

Part number Collet	Reference		Series	Dimensions of the collet (mm)			Ø Thermo- couple max. (mm)	Part number Insulator	Time of delivery
	Model	Ø		ØA	ØB	C			
FFA.0S.703.GN	G	03	0S	0.3	4.0	2.8	0.27	2-polig: PSA.0S.302.ZLL  3-polig: PSA.0S.303.ZLL  4-polig: PSA.0S.304.ZLL	○
FFA.0S.707.GN	G	07		0.7	4.0	2.8	0.60		○
FFA.0S.710.GN	G	10		1.0	4.0	2.8	0.90		●
FFA.0S.712.GN	G	12		1.2	4.0	2.8	1.10		○
FFA.0S.715.GN	G	15		1.5	4.0	2.8	1.40		●
FFA.0S.717.GN	G	17		1.7	4.0	2.8	1.60		○
FFA.0S.720.GN	G	20		2.0	4.0	2.8	1.90		●
FFA.0S.722.GN	G	22		2.2	4.0	2.8	2.10		○
FFA.0S.725.GN	G	25		2.5	4.0	2.8	2.40		●
FFA.0S.727.GN	G	27		2.7	4.0	2.8	2.60		○
FFA.0S.730.GN	G	30		3.0	4.0	2.8	2.90		●
FFA.0S.734.GN	G	34		3.4	5.0	3.7	3.30		○
FFA.0S.742.GN	G	42		4.2	5.0	3.7	4.10		○
FFA.1S.712.GN	G	12	1S	1.2	5.0	3.3	1.10	2-polig: PSA.1S.302.ZLL  3-polig: PSA.1S.303.ZLL  4-polig: PSA.1S.304.ZLL	●
FFA.1S.715.GN	G	15		1.5	5.0	3.3	1.40		●
FFA.1S.717.GN	G	17		1.7	5.0	3.3	1.60		●
FFA.1S.722.GN	G	22		2.2	5.0	3.3	2.10		●
FFA.1S.727.GN	G	27		2.7	5.0	3.3	2.60		●
FFA.1S.732.GN	G	32		3.2	5.0	3.3	3.10		●
FFA.1S.734.GN	G	34		3.4	5.0	3.3	3.30		○
FFA.1S.737.GN	G	37		3.7	5.0	3.3	3.60		○
FFA.1S.742.GN	G	42		4.2	6.0	4.4	4.10		○
FFA.1S.752.GN	G	52		5.2	6.2	4.4	5.10		○
FFA.1S.767.GN	G	67	6.7	8.0	4.4	6.60	○		
FFA.2S.722.GN	G	22	2S	2.2	6.0	7.5	2.10	2-polig: PSA.2S.302.ZLL  3-polig: PSA.2S.303.ZLL  4-polig: PSA.2S.304.ZLL	○
FFA.2S.727.GN	G	27		2.7	6.0	7.5	2.60		○
FFA.2S.734.GN	G	34		3.4	6.0	7.5	3.30		○
FFA.2S.742.GN	G	42		4.2	6.0	7.5	4.10		○
FFA.2S.752.GN	G	52		5.2	8.3	7.5	5.10		○
FFA.2S.767.GN	G	67		6.7	8.3	7.5	6.60		○

- auf Lager  
(Lieferzeit je nach Lagerbestand)  
○ Auftragsfertigung im Werk

- in stock  
(delivery time depends of stock)  
○ order in production

Bestellbeispiel:  
Spannzange: FFA.0S.703.GN  
Isolationsteil, 2-polig: PSA.0S.302.ZLL

Part number example:  
Collet: FFA.0S.703.GN  
Insulator for 2 contacts: PSA.0S.302.ZLL



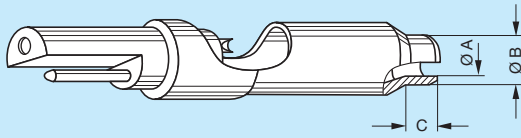

Part number Collet	Reference		Series	Dimensions of the collet (mm)			Ø Thermo- couple max. (mm)	Part number Insulator	Part number Collet/Insulator, fitted	Time of delivery
	Model	Ø		ØA	ØB	C				
FFA.0S.703.NN	N	03	0S	0.30	4.0	2.8	0.25	2-polig: PSA.0S.302.ZLLZ	PSA.0S.30..ZLLN03	○
FFA.0S.705.NN	N	05		0.55	4.0	2.8	0.50		PSA.0S.30..ZLLN05	●
FFA.0S.707.NN	N	07		0.70	4.0	2.8	0.65		PSA.0S.30..ZLLN07	○
FFA.0S.710.NN	N	10		1.00	4.0	2.8	0.95		PSA.0S.30..ZLLN10	●
FFA.0S.712.NN	N	12		1.20	4.0	2.8	1.15		PSA.0S.30..ZLLN12	○
FFA.0S.715.NN	N	15		1.50	4.0	2.8	1.45	3-polig: PSA.0S.303.ZLLZ	PSA.0S.30..ZLLN15	●
FFA.0S.717.NN	N	17		1.70	4.0	2.8	1.65		PSA.0S.30..ZLLN17	○
FFA.0S.720.NN	N	20		2.00	4.0	2.8	1.95		PSA.0S.30..ZLLN20	●
FFA.0S.722.NN	N	22		2.20	4.0	2.8	2.15		PSA.0S.30..ZLLN22	○
FFA.0S.725.NN	N	25		2.50	4.0	2.8	2.45		PSA.0S.30..ZLLN25	●
FFA.0S.727.NN	N	27		2.70	4.0	2.8	2.65	4-polig: PSA.0S.304.ZLLZ	PSA.0S.30..ZLLN27	○
FFA.0S.730.NN	N	30		3.00	4.0	2.8	2.95		PSA.0S.30..ZLLN30	●
FFA.0S.732.NN	N	32		3.25	4.0	2.8	3.20		PSA.0S.30..ZLLN32	○
FFA.0S.734.NN	N	34		3.40	4.0	2.8	3.35		PSA.0S.30..ZLLN34	○
FFA.0S.742.NN	N	42		4.20	5.0	3.7	4.15		PSA.0S.30..ZLLN42	○
FFA.1S.717.NN	N	17	1S	1.70	6.0	5.2	1.65	2-polig: PSA.1S.302.ZLLZ	PSA.1S.30..ZLLN17	○
FFA.1S.722.NN	N	22		2.20	6.0	5.2	2.15	3-polig: PSA.1S.303.ZLLZ	PSA.1S.30..ZLLN22	○
FFA.1S.727.NN	N	27		2.70	6.0	5.2	2.65		PSA.1S.30..ZLLN27	○
FFA.1S.734.NN	N	34		3.40	6.0	5.2	3.35	4-polig: PSA.1S.304.ZLLZ	PSA.1S.30..ZLLN34	○
FFA.1S.742.NN	N	42		4.20	6.0	5.2	4.15		PSA.1S.30..ZLLN42	○
FFA.1S.752.NN	N	52		5.20	6.0	5.2	3.55		PSA.1S.30..ZLLN52	○
FFA.2S.722.NN	N	22	2S	2.20	8.0/4.1	12.5	2.15	2-polig: PSA.2S.302.ZLLZ	PSA.2S.30..ZLLN22	○
FFA.2S.727.NN	N	27		2.70	8.0/4.1	12.5	2.65		PSA.2S.30..ZLLN27	○
FFA.2S.731.NN	N	31		3.10	8.0/4.1	12.5	3.05		PSA.2S.30..ZLLN31	○
FFA.2S.734.NN	N	34		3.40	8.0/4.1	12.5	3.35	3-polig: PSA.2S.303.ZLLZ	PSA.2S.30..ZLLN34	○
FFA.2S.742.NN	N	42		4.20	8.0	12.5	4.15		PSA.2S.30..ZLLN42	○
FFA.2S.746.NN	N	46		4.60	8.0	12.5	4.55		PSA.2S.30..ZLLN46	●
FFA.2S.747.NN	N	47		4.70	8.0	12.5	4.65		PSA.2S.30..ZLLN47	●
FFA.2S.752.NN	N	52		5.20	8.0	12.5	5.15	4-polig: PSA.2S.304.ZLLZ	PSA.2S.30..ZLLN52	○
FFA.2S.761.NN	N	61		6.10	8.0	12.5	6.05		PSA.2S.30..ZLLN61	●
FFA.2S.767.NN	N	67		6.70	8.3	12.5	6.65		PSA.2S.30..ZLLN67	○

- auf Lager  
(Lieferzeit je nach Lagerbestand)
- Auftragsfertigung im Werk

Bestellbeispiel:  
PSA.0S.302.ZLLN03

- in stock  
(delivery time depends of stock)
- order in production

Part number example:  
PSA.0S.302.ZLLN03

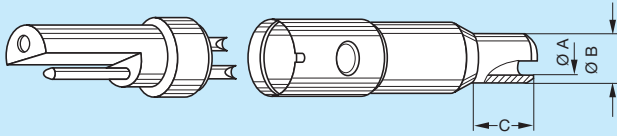

Part number Collet	Reference		Series	Dimensions of the collet (mm)			Ø Thermo- couple max. (mm)	Part number Insulator	Time of delivery
	Model	Ø		ØA	ØB	C			
FFA.0S.703.PN	P	03	0S	0.3	4.0	2.8	0.25	2-polig: PSA.0S.302.ZLL	○
FFA.0S.707.PN	P	07		0.7	4.0	2.8	0.65		○
FFA.0S.712.PN	P	12		1.2	4.0	2.8	1.15	3-polig: PSA.0S.303.ZLL	○
FFA.0S.717.PN	P	17		1.7	4.0	2.8	1.65		○
FFA.0S.722.PN	P	22		2.2	4.0	2.8	2.15	4-polig: PSA.0S.304.ZLL	●
FFA.0S.727.PN	P	27		2.7	4.0	2.8	2.65		○
FFA.0S.734.PN	P	34		3.4	4.0	2.8	3.35	○	
FFA.0S.742.PN	P	42		4.2	5.0	3.7	4.15	○	
FFA.1S.711.PN	P	11	1S	1.1	2.3	4.5	1.05	2-polig: PSA.1S.302.ZLL	●
FFA.1S.712.PN	P	12		1.2	2.3	4.5	1.15		●
FFA.1S.716.PN	P	16		1.6	2.8	4.5	1.55	●	
FFA.1S.721.PN	P	21		2.1	3.2	4.5	2.05	●	
FFA.1S.727.PN	P	27		2.7	4.2	4.5	2.65	○	
FFA.1S.732.PN	P	32		3.2	4.2	4.5	3.15	3-polig: PSA.1S.303.ZLL	●
FFA.1S.734.PN	P	34		3.4	5.8	5.0	3.35		○
FFA.1S.742.PN	P	42		4.2	5.8	5.0	4.15	○	
FFA.1S.746.PN	P	46		4.6	5.8	5.0	4.55	○	
FFA.1S.752.PN	P	52		5.2	6.0	5.0	5.15	4-polig: PSA.1S.304.ZLL	○
FFA.1S.761.PN	P	61		6.1	7.0	5.0	6.05		●
FFA.1S.700.PN	P	00		zent.	5.8	5.0	–	●	
FFA.2S.722.PN	P	22	2S	2.2	8.0/4.1	12.5	2.15	2-polig: PSA.2S.302.ZLL	○
FFA.2S.727.PN	P	27		2.7	8.0/4.1	12.5	2.65		○
FFA.2S.734.PN	P	34		3.4	8.0/4.1	12.5	3.35	○	
FFA.2S.742.PN	P	42		4.2	8.0	6.0	4.15	3-polig: PSA.2S.303.ZLL	○
FFA.2S.746.PN	P	46		4.6	5.8	6.0	4.55		●
FFA.2S.752.PN	P	52		5.2	8.0	6.0	5.15	○	
FFA.2S.761.PN	P	61		6.1	7.4	6.0	6.05	4-polig: PSA.2S.304.ZLL	●
FFA.2S.767.PN	P	67		6.7	8.0	6.0	6.65		○
FFA.2S.700.PN	P	00		zent.	7.4	6.0	–	●	

- auf Lager  
(Lieferzeit je nach Lagerbestand)  
○ Auftragsfertigung im Werk

- in stock  
(delivery time depends of stock)  
○ order in production

Bestellbeispiel:  
Spannzange: FFA.0S.703.PN  
Isolationsteil, 2-polig: PSA.0S.302.ZLL

Part number example:  
Collet: FFA.0S.703.PN  
Insulator for 2 contacts: PSA.0S.302.ZLL

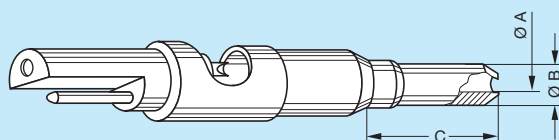

Part number Collet	Reference		Series	Dimensions of the collet (mm)			Ø Thermo- couple max. (mm)	Part number Insulator	Part number Collet/Insulator, fitted	Time of delivery	
	Model	Ø		ØA	ØB	C					
FFA.0S.702.RN	R	02	0S	0.25	3.20	12.5	0.20	2-polig: PSA.0S.302.ZLLZ	PSA.0S.30..ZLLR02	●	
FFA.0S.703.RN	R	03		0.30	3.20	12.5	0.25		PSA.0S.30..ZLLR03	○	
FFA.0S.705.RN	R	05		0.50	3.20	12.5	0.45		PSA.0S.30..ZLLR05	●	
FFA.0S.707.RN	R	07		0.70	3.20	12.5	0.65		PSA.0S.30..ZLLR07	○	
FFA.0S.710.RN	R	10		1.00	3.20	12.5	0.95		PSA.0S.30..ZLLR10	●	
FFA.0S.711.RN	R	11		1.10	3.20	12.5	1.05		3-polig: PSA.0S.303.ZLLZ	PSA.0S.30..ZLLR11	●
FFA.0S.712.RN	R	12		1.20	2.40	12.5	1.15			PSA.0S.30..ZLLR12	●
FFA.0S.716.RN	R	16		1.60	3.20	12.5	1.55		PSA.0S.30..ZLLR16	●	
FFA.0S.717.RN	R	17		1.70	3.20	12.5	1.65		PSA.0S.30..ZLLR17	○	
FFA.0S.720.RN	R	20		2.00	3.20	12.5	1.95		4-polig: PSA.0S.304.ZLLZ	PSA.0S.30..ZLLR20	●
FFA.0S.722.RN	R	22		2.20	3.20	12.5	2.15			PSA.0S.30..ZLLR22	○
FFA.0S.726.RN	R	26		2.60	3.45	12.5	2.55			PSA.0S.30..ZLLR26	●
FFA.0S.727.RN	R	27		2.70	3.45	12.5	2.65			PSA.0S.30..ZLLR27	○
FFA.0S.732.RN	R	32		3.20	4.10	12.5	3.15			PSA.0S.30..ZLLR32	○
FFA.1S.712.RN	R	12	1S	1.20	3.20	10.2	1.15	2-polig: PSA.1S.302.ZLLZ	PSA.1S.30..ZLLR12	○	
FFA.1S.716.RN	R	16		1.60	3.20	10.2	1.55		PSA.1S.30..ZLLR16	●	
FFA.1S.717.RN	R	17		1.70	3.20	10.2	1.65		PSA.1S.30..ZLLR17	○	
FFA.1S.720.RN	R	20		2.00	3.20	10.2	1.95		PSA.1S.30..ZLLR20	●	
FFA.1S.722.RN	R	22		2.20	3.50	10.5	2.15		3-polig: PSA.1S.303.ZLLZ	PSA.1S.30..ZLLR22	○
FFA.1S.727.RN	R	27		2.70	3.70	10.5	2.65			PSA.1S.30..ZLLR27	○
FFA.1S.731.RN	R	31		3.10	4.40	11.2	3.05		PSA.1S.30..ZLLR31	●	
FFA.1S.733.RN	R	33		3.30	4.40	11.2	3.25		PSA.1S.30..ZLLR33	●	
FFA.1S.734.RN	R	34		3.40	4.40	11.2	3.35		4-polig: PSA.1S.304.ZLLZ	PSA.1S.30..ZLLR34	○
FFA.1S.736.RN	R	36		3.60	4.40	11.2	3.55			PSA.1S.30..ZLLR36	●
FFA.1S.746.RN	R	46		4.60	5.80	12.4	4.55			PSA.1S.30..ZLLR46	●

- auf Lager  
(Lieferzeit je nach Lagerbestand)
- Auftragsfertigung im Werk

Bestellbeispiel:  
PSA.0S.302.ZLLR03

- in stock  
(delivery time depends of stock)
- order in production

Part number example:  
PSA.0S.302.ZLLR03

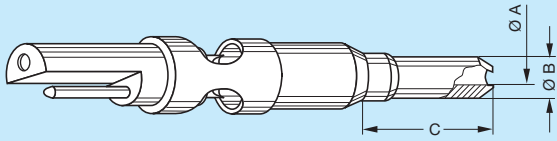

Part number Collet	Reference		Series	Dimensions of the collet (mm)			Ø Thermo- couple max. (mm)	Part number Insulator	Part number Collet/Insulator, fitted	Time of delivery
	Model	Ø		ØA	ØB	C				
			0S					2-polig: PSA.0S.302.ZLLZ		
FFA.0S.726.QN	Q	26		2.6	3.45	12.5	2.55	3-polig: PSA.0S.303.ZLLZ	PSA.0S.30•.ZLLQ26	●
								4-polig: PSA.0S.304.ZLLZ		
			1S					2-polig: PSA.1S.302.ZLLZ		
FFA.1S.731.QN	Q	31		3.1	4.4	11.2	3.05	3-polig: PSA.1S.303.ZLLZ	PSA.1S.30•.ZLLQ31	●
								4-polig: PSA.1S.304.ZLLZ		
			2S					2-polig: PSA.2S.302.ZLLZ		
FFA.2S.700.QN	Q	00		zent.	8.0	13.5	–	3-polig: PSA.2S.303.ZLLZ	PSA.2S.30•.ZLLQ70	●
FFA.2S.746.QN	Q	46		4.6	5.8	11.5	4.55	4-polig: PSA.2S.304.ZLLZ	PSA.2S.30•.ZLLQ46	●

- auf Lager  
(Lieferzeit je nach Lagerbestand)
- Auftragsfertigung im Werk

Bestellbeispiel:  
PSA.0S.302.ZLLQ26

- in stock  
(delivery time depends of stock)
- order in production

Part number example:  
PSA.0S.302.ZLLQ26

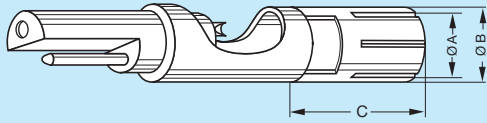

Part number Collet	Reference		Series	Dimensions of the collet (mm)			Ø Thermo-couple max. (mm)	Part number Insulator	Part number Collet/Insulator, fitted	Time of delivery
	Model	Ø		ØA	ØB	C				
			0S					2-polig: PSA.0S.302.ZLLZ		
FFA.0S.748.LNY	Y	48		5.0	5.7	9.2	4.8	3-polig: PSA.0S.303.ZLLZ	PSA.0S.30•.ZLLY48	●
								4-polig: PSA.0S.304.ZLLZ		

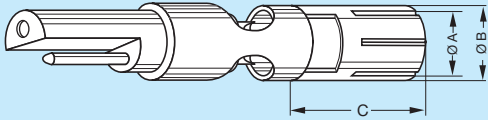

Part number Collet	Reference		Series	Dimensions of the collet (mm)			Ø Thermo-couple max. (mm)	Part number Insulator	Part number Collet/Insulator, fitted	Time of delivery
	Model	Ø		ØA	ØB	C				
			0S					2-polig: PSA.0S.302.ZLLZ		
FFA.0S.748.LN	L	48		5.0	5.7	9.2	4.8	3-polig: PSA.0S.303.ZLLZ	PSA.0S.30•.ZLLL48	●
								4-polig: PSA.0S.304.ZLLZ		

- auf Lager (Lieferzeit je nach Lagerbestand)
- Auftragsfertigung im Werk

Bestellbeispiel:  
 PSA.0S.302.ZLLY48  
 PSA.0S.302.ZLLL48

- in stock (delivery time depends of stock)
- order in production

Part number example:  
 PSA.0S.302.ZLLY48  
 PSA.0S.302.ZLLL48

**Konstruktions-Information**  
**E Serie wasserdicht**

**Constructions information**  
**E Series watertight**

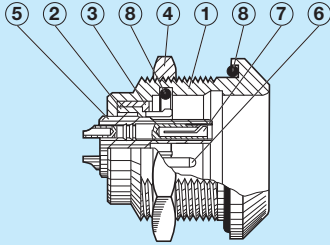

**Fixed socket**

- ① Outer shell
- ② Earthing crown
- ③ Retaining ring
- ④ Hexagonal nut
- ⑤ Insulator
- ⑥ Male contact
- ⑦ Female contact
- ⑧ O-ring

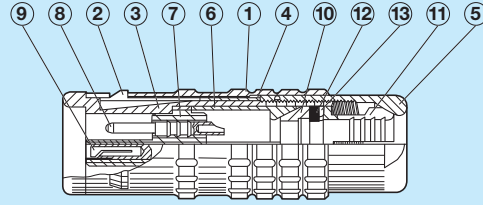

**Straight plug**

- ① Outer shell
- ② Latch sleeve
- ③ Inner shell
- ④ Retaining ring
- ⑤ Collet nut
- ⑥ Split insert carrier
- ⑦ Insulator
- ⑧ Male contact
- ⑨ Female contact
- ⑩ Earthing cone
- ⑪ Collet
- ⑫ Gasket
- ⑬ Washer

**Bestellbeispiele**

**Part number example**

**Stecker, gerade, wasserdicht**

**Straight plug, watertight**

FFA 1E 302 C L A C 35

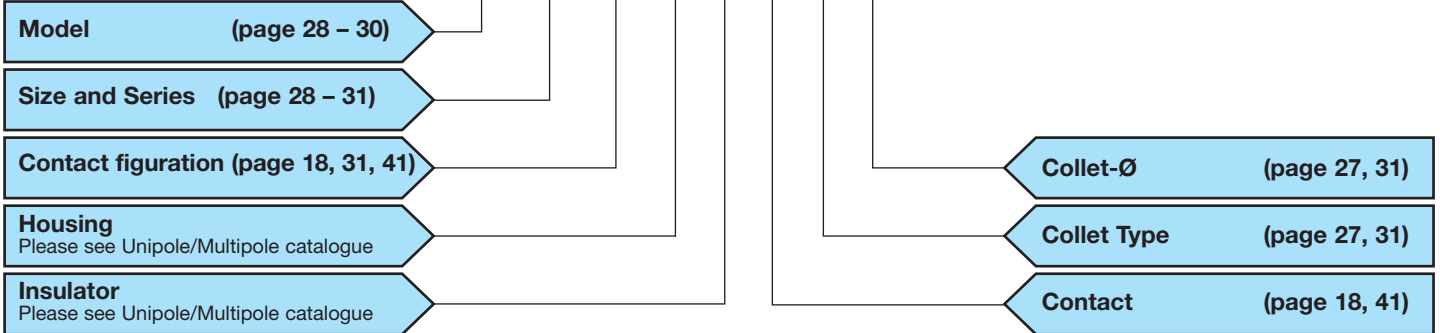

Stecker, gerade, Größe 1, E Serie, 2-polig, Außenkörper aus Messing verchromt, Isolations- teil aus PEEK, männlicher und weiblicher Löt- kontakt, Spannzange für geschirmtes Kabel mit einem Durchmesser von 3,2 mm.

Straight plug, size 1, E Series, 2 contacts, chromed brass shell, PEEK insulator, male and female solder contact, brazing collet for insulated cable having a diameter of 3.2 mm.

**Kabelkupplung, wasserdicht**

**Free socket, watertight**

PCA 0E 302 C L L R 12

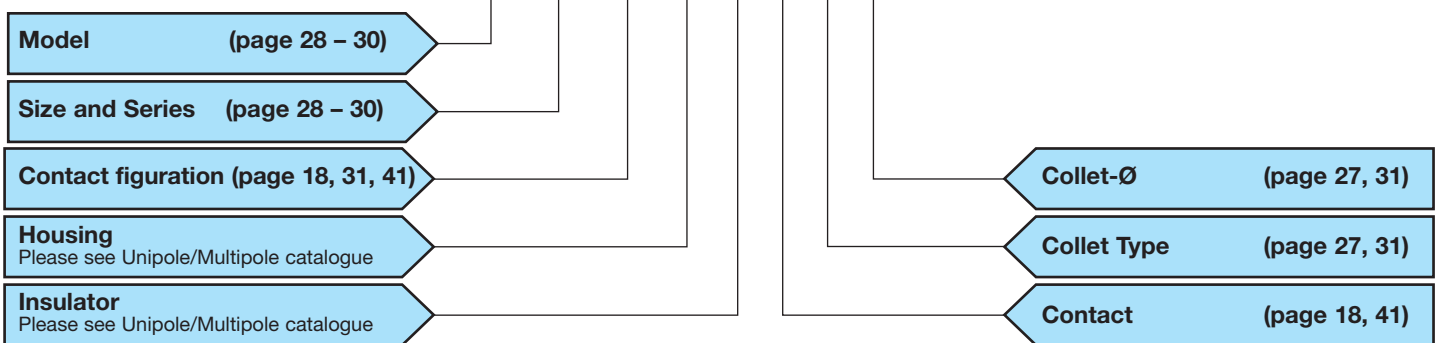

Kabelkupplung, Größe 0, S Serie, 2-polig, Außenkörper aus Messing verchromt, Isolations- teil aus PEEK, männlicher und weiblicher Löt- kontakt und TH-Spannzange Typ R12.

Free socket, size 0, S Series, 2 contacts, chromed brass shell, PEEK insulator, male and female solder contact and TH collet type R12.



E Series – Size 0/1/2

E Serie – Größe 0/1/2

Reference		C = AG					L = NG		K = Adapter to the next size	
		Ø Collet (mm)		Ø Gasket (mm)	Ø Cable (mm)		Part number collet 1)	Re- marks	Part number adapter 2)	Part number Collet nut 2)
Model	Ø	ØA	ØB		max.	min.				
C	10	1,6	–	1,0	1,2	1,0	FFA.0E.710.CNS	○		FFA.00.130.LC
C	15	1,6	–	1,5	1,5	1,3	FFA.0E.715.CNS	●		FFA.00.130.LC
C	20	2,1	–	2,0	2,0	1,6	FFA.0E.720.CNS	●		FFA.00.130.LC
C	25	3,1	–	2,5	2,5	2,1	FFA.0E.725.CNS	●		FFA.00.130.LC
C	30	3,1	–	3,0	3,0	2,6	FFA.0E.730.CNS	●		FFA.00.130.LC
C	35	4,2	4,2	3,5	3,5	3,1	FFA.0E.735.CNS	●		FFA.00.130.LC
C	40	4,2	4,2	4,0	4,0	3,6	FFA.0E.740.CNS	●		FFA.00.130.LC
C	45	4,5	4,5	4,5	4,5	4,1	FFA.0E.745.CNS	●		FFA.00.130.LC
C	50	5,0	5,0	4,6	5,0	4,6	FFA.0E.750.CNS	●		FFA.00.130.LC
C	15	1,6	–	1,5	1,5	1,0	FFA.1E.715.CNS	●		FFA.1E.130.LC
C	20	2,2	–	2,0	2,0	1,6	FFA.1E.720.CNS	○		FFA.1E.130.LC
C	25	3,2	–	2,5	2,5	2,1	FFA.1E.725.CNS	●		FFA.1E.130.LC
C	30	3,2	–	3,0	3,0	2,6	FFA.1E.730.CNS	●		FFA.1E.130.LC
C	35	4,2	–	3,5	3,5	3,1	FFA.1E.735.CNS	●		FFA.1E.130.LC
C	40	4,2	–	4,0	4,0	3,6	FFA.1E.740.CNS	●		FFA.1E.130.LC
C	45	5,2	–	4,5	4,5	4,1	FFA.1E.745.CNS	●		FFA.1E.130.LC
C	50	5,2	–	5,0	5,0	4,6	FFA.1E.750.CNS	●		FFA.1E.130.LC
C	55	6,2	6,2	5,5	5,5	5,1	FFA.1E.755.CNS	●		FFA.1E.130.LC
C	60	6,2	6,2	6,0	6,0	5,6	FFA.1E.760.CNS	●		FFA.1E.130.LC
C	65	7,2	6,7	6,5	6,7	6,1	FFA.1E.765.CNS	●		FFA.1E.130.LC
K	70	7,2	–	7,0	7,0	6,6	FFA.2E.770.CNS	●	FFA.1E.137.LCN	FFA.2E.130.LC
K	75	8,2	8,2	7,5	7,5	7,1	FFA.2E.775.CNS	●	FFA.1E.137.LCN	FFA.2E.130.LC
K	80	8,2	8,2	8,0	8,0	7,6	FFA.2E.780.CNS	●	FFA.1E.137.LCN	FFA.2E.130.LC
K	85	9,2	8,6	8,5	8,5	8,1	FFA.2E.785.CNS	●	FFA.1E.137.LCN	FFA.2E.130.LC
C	15	2,2	–	1,5	1,7	1,5	FFA.2E.715.CNS	○		FFA.2E.130.LC
C	20	2,2	–	2,0	2,0	1,8	FFA.2E.720.CNS	○		FFA.2E.130.LC
C	25	3,2	–	2,5	2,5	2,1	FFA.2E.725.CNS	●		FFA.2E.130.LC
C	30	3,2	–	3,0	3,0	2,6	FFA.2E.730.CNS	●		FFA.2E.130.LC
C	35	4,2	–	3,5	3,5	3,1	FFA.2E.735.CNS	●		FFA.2E.130.LC
C	40	4,2	–	4,0	4,0	3,6	FFA.2E.740.CNS	●		FFA.2E.130.LC
C	45	5,2	–	4,5	4,5	4,1	FFA.2E.745.CNS	●		FFA.2E.130.LC
C	50	5,2	–	5,0	5,0	4,6	FFA.2E.750.CNS	●		FFA.2E.130.LC
C	55	6,2	–	5,5	5,5	5,1	FFA.2E.755.CNS	●		FFA.2E.130.LC
C	60	6,2	–	6,0	6,0	5,6	FFA.2E.760.CNS	●		FFA.2E.130.LC
C	65	7,2	–	6,5	6,5	6,1	FFA.2E.765.CNS	●		FFA.2E.130.LC
C	70	7,2	–	7,0	7,0	6,6	FFA.2E.770.CNS	●		FFA.2E.130.LC
C	75	8,2	8,2	7,5	7,5	7,1	FFA.2E.775.CNS	●		FFA.2E.130.LC
C	80	8,2	8,2	8,0	8,0	7,6	FFA.2E.780.CNS	●		FFA.2E.130.LC
C	85	9,2	8,6	8,5	8,5	8,1	FFA.2E.785.CNS	●		FFA.2E.130.LC
K	90	9,2	–	9,0	9,0	8,6	FFA.3E.790.CNS	●	FFA.2E.137.LCN	FFA.3E.130.LC
K	95	10,2	10,2	9,5	9,5	9,1	FFA.3E.795.CNS	●	FFA.2E.137.LCN	FFA.3E.130.LC
K	10	10,2	10,2	10,0	10,0	9,6	FFA.3E.710.CNS	●	FFA.2E.137.LCN	FFA.3E.130.LC
K	11	11,2	10,6	11,0	11,0	10,1	FFA.3E.711.CNS	●	FFA.2E.137.LCN	FFA.3E.130.LC

1) Für Einzelbestellung der Spannzangen.

2) Für Einzelbestellung einer Spannzange der Type K benötigt man je einen Adapter und eine Spannschraube (Bestell-Nr. siehe oben).

● lieferbar ○ auf Anfrage

1) For individual orders of collets.

2) For individual orders of a collet type K an adapter each is required as well as a collet nut (part number is mentioned above).

● in stock ○ on request

**E Series watertight**  
**E Serie wasserdicht**

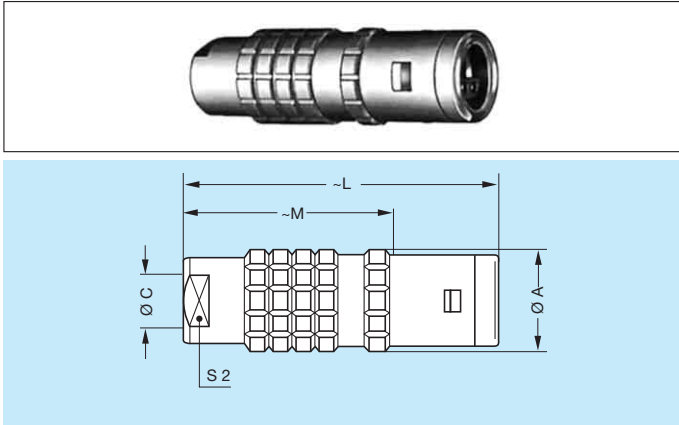

**Watertight, straight plug**  
**Wasserdichter Stecker, gerade**

Reference		Dimensions (mm)				
Model	Series	A	C	L	M	S2
FFA	0E	11	6.2	34	23.0	7.9
FFA	1E	13	7.1	42	28.0	8.9
FFA	2E	16	9.2	52	36.0	11.9

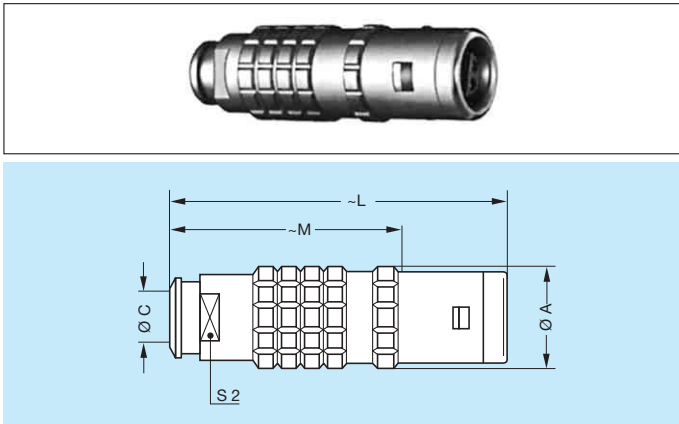

**Watertight plug with cable collet and nut for fitting a strain relief**  
**Wasserdichter Stecker mit Knickschutzschraube**

Reference		Dimensions (mm)				
Model	Series	A	C	L	M	S2
FFA	0E	11	5.2	37	26	7.0
FFA	1E	13	7.1	45	31	9.0
FFA	2E	16	8.7	49	33	11.9



**Watertight socket**      **Wasserdichte Einbauapparatdose**

Reference		Dimensions (mm)													
Model	Series	A	B	e	E	L	L1	L2	L3	L4	L5	L6	M	S1	S3
ERA	0E	18	19.5	M14x1	7.0	19.0	20.0	19.0	26.0	21.4	-	-	4.0	12.5	17
ERA	1E	20	21.5	M16x1	9.0	26.0	25.4	20.4	36.0	27.2	-	-	4.5	14.5	19
ERA	2E	25	27.5	M20x1	9.0	29.0	30.0	28.8	45.8	30.3	-	-	5.0	18.5	24

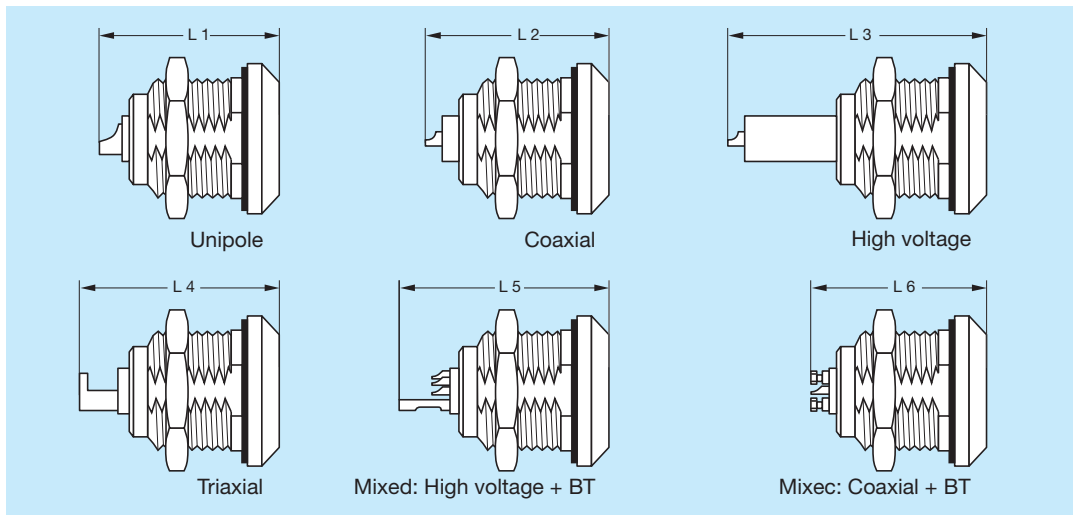
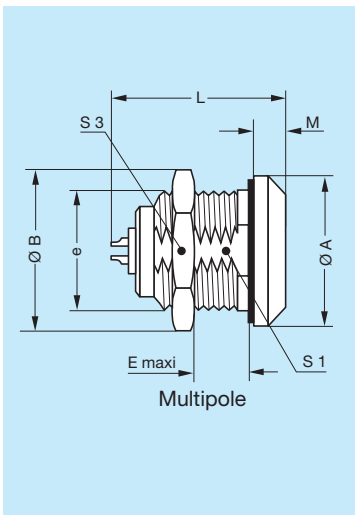

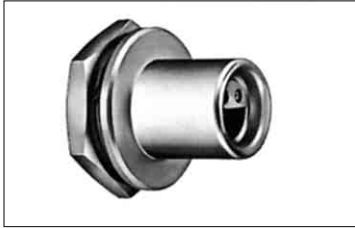

**Watertight plug non-latching**  
**Wasserdichte, positive Apparatedose (Einbaustecker)**

Reference		Dimensions (mm)											
Model	Series	A	B	e	E	L	L1	L2	L3	L4	M	S1	S3
FAA	2E	25	27.5	M20x1	4	34	29	25	53	37	18	18.5	24

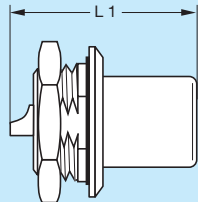
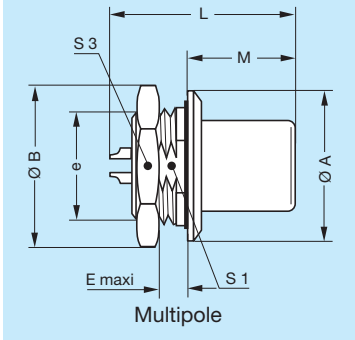

Unipole

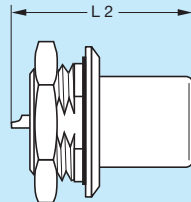

Coaxial

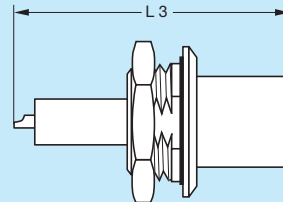

High voltage

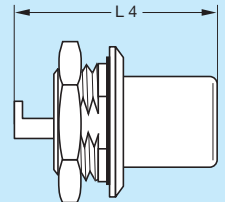

Triaxial

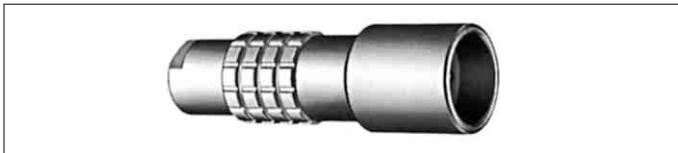

**Watertight free socket**  
**Wasserdichte Kabelkupplung**

Reference		Dimensions (mm)			
Model	Series	A	C	L	S2
PCA	0E	13	6.2	34.0	7.9
PCA	1E	15	7.1	45.0	8.9
PCA	2E	19	9.2	54.0	11.9

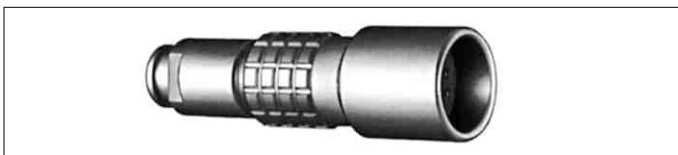
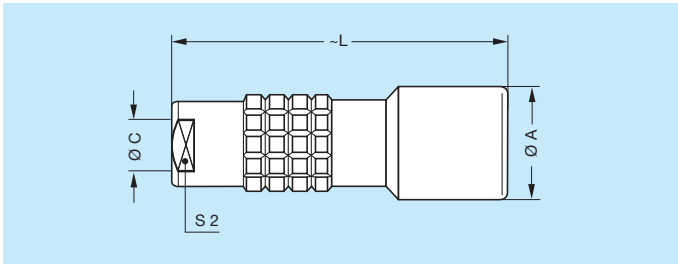

**Watertight socket with cable collet and nut**  
**for fitting a strain relief**  
**Wasserdichte Kabelkupplung mit**  
**Knickschutzspannschraube**

Reference		Dimensions (mm)			
Model	Series	A	C	L	S2
PCA	0E	13	6.2	37.0	7.0
PCA	1E	15	7.1	48.0	9.0
PCA	2E	19	9.2	57.0	11.9

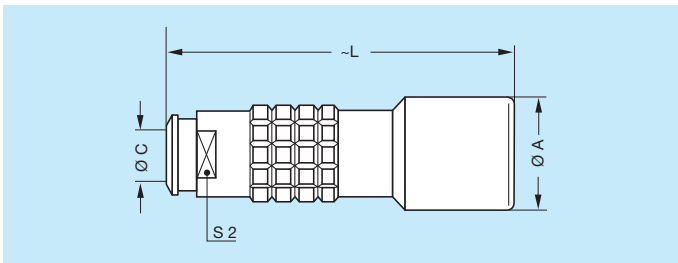

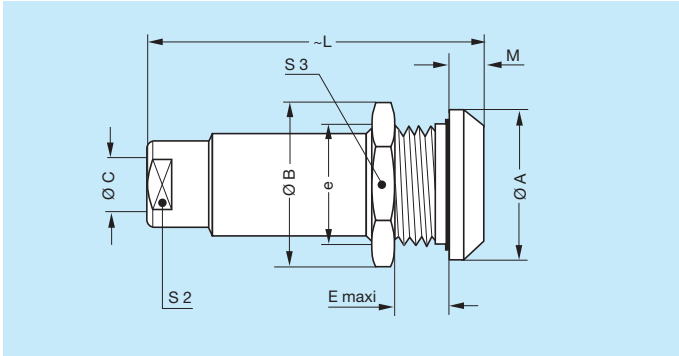
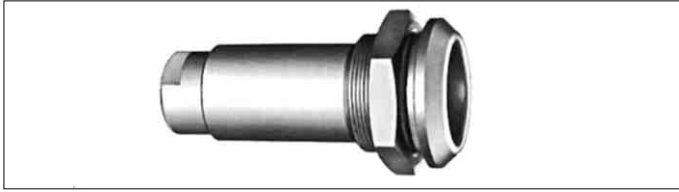

**Watertight fixed socket with cable collet**  
**Wasserdichte Einbauapparatdose mit**  
**Zugentlastung**

Reference		Dimensions (mm)								
Model	Series	A	B	C	e	E	L	M	S2	S3
PSA	0E	18	19.5	6.2	M14x1	7.0	34.0	4.0	7.9	17
PSA	1E	20	21.5	7.1	M16x1	9.0	45.0	4.5	8.9	19
PSA	2E	25	27.5	9.2	M20x1	9.0	54.0	5.0	11.9	24

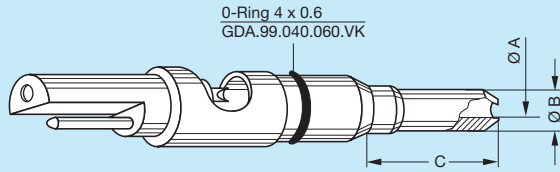

Part number Collet	Reference		Series	Dimensions of the collet (mm)			Ø Thermo-couple max. (mm)	Part number Insulator	Part number Collet/Insulator, fitted	Time of delivery
	Typ	Ø		ØA	ØB	C				
FFA.0E.702.RNS	R	02	0E	0.25	3.20	12.5	0.20	2-polig: PSA.0S.302.ZLLZ	PSA.0E.30.ZLLR02	●
FFA.0E.705.RNS	R	05		0.50	3.20	12.5	0.45		PSA.0E.30.ZLLR05	●
FFA.0E.710.RNS	R	10		1.00	3.20	12.5	0.95		PSA.0E.30.ZLLR10	●
FFA.0E.711.RNS	R	11		1.10	3.20	12.5	1.05	3-polig: PSA.0S.303.ZLLZ	PSA.0E.30.ZLLR11	●
FFA.0E.712.RNS	R	12		1.20	2.40	12.5	1.15		PSA.0E.30.ZLLR12	●
FFA.0E.716.RNS	R	16		1.60	3.20	12.5	1.55	4-polig: PSA.0S.304.ZLLZ	PSA.0E.30.ZLLR16	●
FFA.0E.720.RNS	R	20		2.00	3.20	12.5	1.95		PSA.0E.30.ZLLR20	●
FFA.0E.726.RNS	R	26		2.60	3.45	12.5	2.55		PSA.0E.30.ZLLR26	●

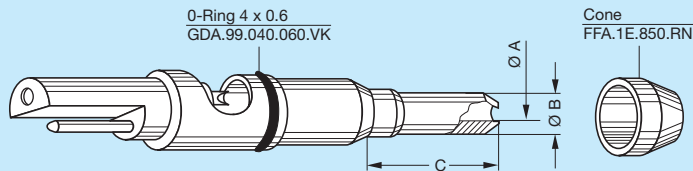

Part number Collet	Reference		Series	Dimensions of the collet (mm)			Ø Thermo-couple max. (mm)	Part number Insulator	Part number Collet/Insulator, fitted	Time of delivery
	Typ	Ø		ØA	ØB	C				
FFA.1E.716.RNS	R	16	1E	0.6	3.2	10.2	1.55	2-polig: PSA.1S.302.ZLLZ	PSA.1E.30.ZLLR16	●
FFA.1E.720.RNS	R	20		2.0	3.2	10.2	1.95		PSA.1E.30.ZLLR20	●
FFA.1E.731.RNS	R	31		3.1	4.5	11.3	3.05	3-polig: PSA.1S.303.ZLLZ	PSA.1E.30.ZLLR31	●
FFA.1E.733.RNS	R	33		3.3	4.4	11.2	3.25		PSA.1E.30.ZLLR33	●
FFA.1E.736.RNS	R	36		3.6	4.4	11.3	3.55	4-polig: PSA.1S.304.ZLLZ	PSA.1E.30.ZLLR36	●
FFA.1E.746.RNS	R	46		4.6	5.8	12.4	4.55		PSA.1E.30.ZLLR46	●

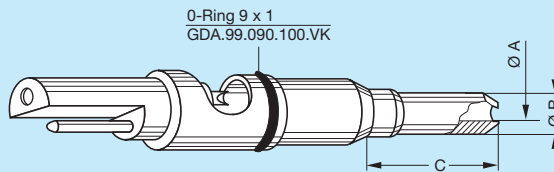

Part number Collet	Reference		Series	Dimensions of the collet (mm)			Ø Thermo-couple max. (mm)	Part number Insulator	Part number Collet/Insulator, fitted	Time of delivery
	Typ	Ø		ØA	ØB	C				
			2E					2-polig: PSA.2S.302.ZLLZ		
FFA.2E.746.RNS	R	46		4.6	5.8	12.5	4.55		3-polig: PSA.2S.303.ZLLZ	PSA.2E.30.ZLLR46
								4-polig: PSA.2S.304.ZLLZ		

- auf Lager (Lieferzeit je nach Lagerbestand)
- Auftragsfertigung im Werk

Bestellbeispiel:  
PSA.0E.302.ZLLR02  
PSA.1E.302.ZLLR16  
PSA.2E.302.ZLLR46

- in stock (delivery time depends of stock)
- order in production

Part number example:  
PSA.0E.302.ZLLR02  
PSA.1E.302.ZLLR16  
PSA.2E.302.ZLLR46

Konstruktions-Information  
B Serie

Constructions information  
B Series

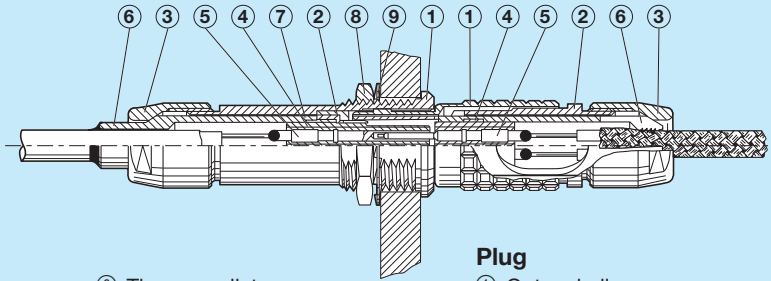

**Fixed socket**

- ① Outer shell
- ② Earthing crown
- ③ Collet nut
- ④ Insulator
- ⑤ Female contact
- ⑥ Thermo collet
- ⑦ Retaining ring
- ⑧ Hexagonal nut
- ⑨ Locking washer

**Plug**

- ① Outer shell
- ② Latch sleeve
- ③ Collet nut
- ④ Insulator
- ⑤ Male contact
- ⑥ Collet

Bestellbeispiele

Part number example

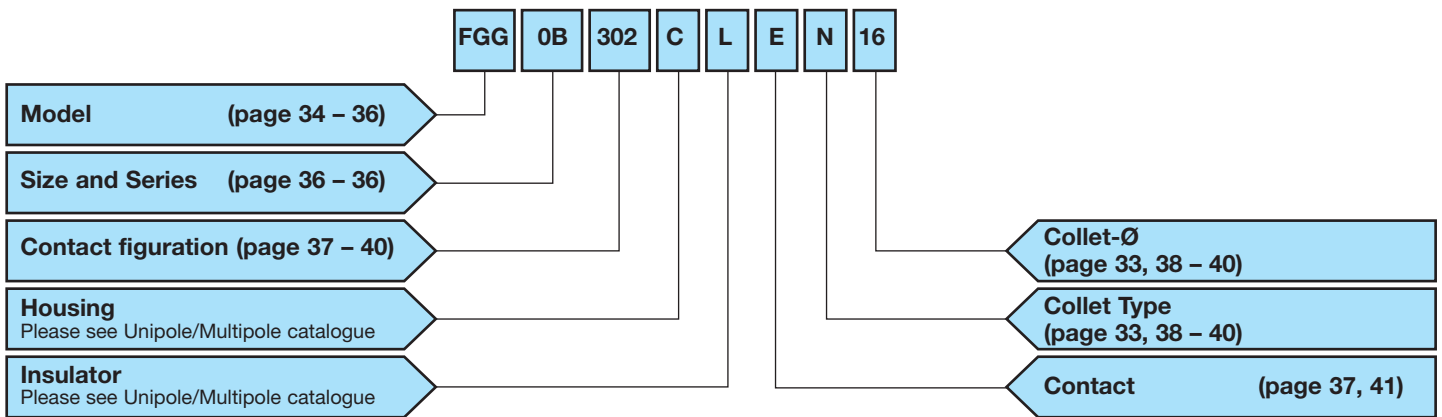

Stecker, gerade, mit Führungsnocke (G), Größe 0, B Serie, 2 Kontakte, Außenkörper aus Messing verchromt, Isolationsteil aus PEEK, Thermokontakt Typ E, Thermospannzange Typ N für geschirmtes Kabel mit einem max. Durchmesser von 1,55 mm.

Straight plug with key (G) and cable collet, size 0, B Series, 2 contacts, chrome plated brass housing, PEEK insulator, thermocouple type E, brazing collet type N for insulated cable with a max. diameter of 1,55 mm.

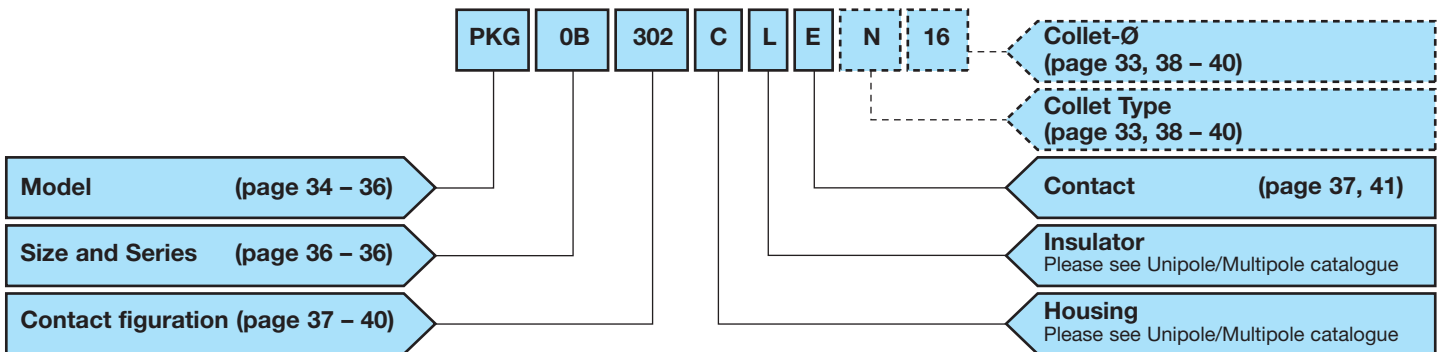

Einbauapparatedose mit Führungsnut (G) und Zugentlastung, Größe 0, B Serie, mehrpolig (2 Kontakte), Außenkörper aus Messing verchromt, Massekrone vernickelt, Isolationsteil aus PEEK, Thermokontakt Typ E, Thermospannzange Typ N für Thermoelemente mit einem Durchmesser von 1,6 mm.

Receptacle with key (G) and cable collet, size 0, B Series, 2 contacts, chrome plated brass housing, nickel earth crown, PEEK insulator, thermocouple type E, brazing collet type N for thermocouples having a diameter of 1,6 mm.



**Collets – Type and Diameter**

**Spannzangen – Typ und Durchmesser**

Reference		Ø Collet (mm)		Ø Cable (mm)		Part number Collet	Part number Reducer	Part number Reducing Cone	Re-remarks
		ØA	ØB	max.	min.				
Model	Ø	Serie							
D	21	0B	2,1		2,0	1,5	FGG.0B.721.DN		
D	31		3,1		3,0	2,1	FGG.0B.731.DN		
D	42		4,2		4,0	3,1	FGG.0B.742.DN		
D	52		5,2	4,7	5,0	4,1	FGG.0B.752.DN		
D	56		5,6	4,7	5,5	5,1	FGG.0B.756.DN		1)
M	27	1B	2,7		2,5	2,0	FFA.00.727.CN	FGG.1B.138.LN	FGG.1B.158.LN
M	31		3,1		3,0	2,1	FFA.00.731.CN	FGG.1B.138.LN	FGG.1B.158.LN
D	42		4,2		4,0	3,1	FGG.1B.742.DN		
D	52		5,2		5,0	4,1	FGG.1B.752.DN		
D	62		6,2		6,0	5,1	FGG.1B.762.DN		
D	72		7,2	6,7	7,0	6,1	FGG.1B.772.DN		
D	76		7,6	6,7	7,5	7,1	FGG.1B.776.DN		1)
M	21	2B	2,1		2,0	1,5	FGG.0B.721.DN	FGG.2B.138.LN	FGG.2B.158.LN
M	31		3,1		3,0	2,1	FGG.0B.731.DN	FGG.2B.138.LN	FGG.2B.158.LN
M	42		4,2		4,0	3,1	FGG.2B.742.DN	FGG.2B.138.LN	FGG.2B.158.LN
D	52		5,2		5,0	4,1	FGG.2B.752.DN		
D	62		6,2		6,0	5,1	FGG.2B.762.DN		
D	72		7,2		7,0	6,1	FGG.2B.772.DN		
D	82		8,2		8,0	7,1	FGG.2B.782.DN		
D	92		9,2	8,6	9,0	8,1	FQG.2B.792.DN		
D	99		9,9	8,6	9,7	9,1	FGG.2B.799.DN		1)

<sup>1)</sup> Diese Spannzangen können nicht in Bauformen mit Spansschrauben für Knickschutztüllen verwendet werden. Bei den anderen Steckern mit Kabelspannzangen muß die Bestellnummer der zugehörigen Spansschraube, FFM...\_...130.LC, ebenfalls in der Bestellung aufgeführt werden.

<sup>1)</sup> These collets cannot be used for connector models with nut for fitting a bend relief. For any other plug with cable collets, please indicate the part number of the corresponding collet nut, FFM...\_...130.LC in your order.

**Bestellinformationen und Bauformen zur K Serie siehe Katalog Unipole/Multipole Connectors**

**Order information and designs about the K Series please see catalogue Unipole/Multipole connectors**

**B Series with alignment key and polarized keying system**

**B Serie mit Codierungssystem**

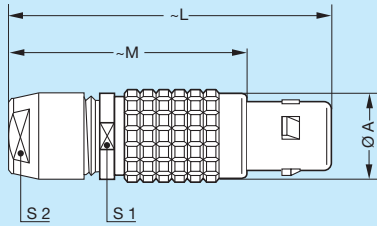

**Straight plug with key G or keys (code A...M and R), cable collet**

**Gerader Stecker mit Führungsnocke (G) oder Verschlüsselung (Code A...M und R), Zugentlastung**

Reference		Dimensions (mm)				
Model	Series	A	L	M	S1	S2
FGG	00	6.4	28.5	20.5	5.5	5
FGG	0B	9.5	36	26	8	7
FGG	1B	12.0	43	32	10	9
FGG	2B	15.0	49	37	13	12

**M1** Assembly instruction: see Unipole/Multipole catalogue  
Montageanweisungen: siehe Unipole/Multipole Katalog

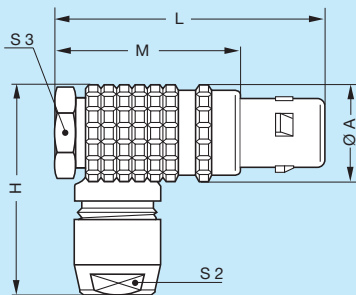

**Elbow plug with key G or keys (code A...M and R), cable collet**

**Winkelstecker mit Führungsnocke (G) oder Verschlüsselung (Code A...M und R), Zugentlastung**

Reference		Dimensions (mm)					
Model	Series	A	H	L	M	S2	S3
FHG	00	7.7	18	24.5	16.5	5	7
FHG	0B	11.0	23	30.0	20.0	7	9
FHG	1B	13.5	28	36.0	25.0	9	11
FHG	2B	16.5	34	41.5	29.5	12	14

**M3** Assembly instruction: see Unipole/Multipole catalogue  
Montageanweisungen: siehe Unipole/Multipole Katalog

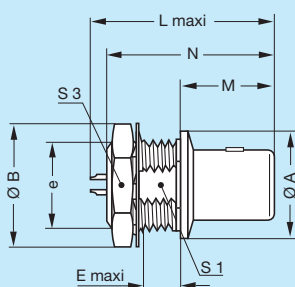

**Straight plug, non-latching, nut fixing, with key (code A...M and R)**

**Gerader Stecker ohne Verriegelung, mit Führungsnocke (Code A...M und R), Befestigung mit Mutter**

Reference		Dimensions (mm)								
Model	Series	A	B	e	E	L	M	N	S1	S3
FAG	00	8	10.3	M7x0.5	2.0	15.5	9.0	14.5	6.3	9
FAG	0B	10	12.5	M9x0.6	3.5	20.0	11.2	18.0	8.2	11
FAG	1B	14	16.0	M12x 1	7.0	26.5	12.5	22.5	10.5	14
FAG	2B	18	19.5	M15x 1	7.0	25.5	13.8	23.5	13.5	17

**P1** Panel cut out: see Unipole/Multipole catalogue  
Bohrplan der Frontplatte: siehe Unipole/Multipole Katalog

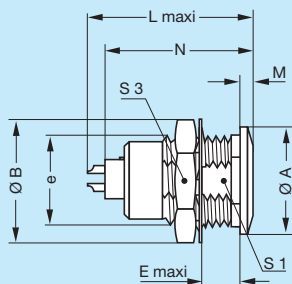

**Fixed socket with key G or keys (code A...M and R)**  
**Apparatedose mit Führungsnocke (G) oder Verschlüsselung (Code A...M und R), Befestigung mit Mutter**

Reference		Dimensions (mm)								
Model	Series	A	B	e	E	L	M	N	S1	S3
EGG	00	8	10.3	M7x0.5	5.5	15.5	1.0	12.0	6.3	9
EGG	0B	10	12.5	M9x0.6	7.0	19.5	1.2	17.5	8.2	11
EGG	1B	14	16.0	M12x 1	7.5	21.7	1.5	19.5	10.5	14
EGG	2B	18	20.0	M15x 1	8.5	25.0	1.8	21.5	13.5	17

P1 Panel cut out: see Unipole/Multipole catalogue  
 Bohrplan der Frontplatte: siehe Unipole/Multipole Katalog

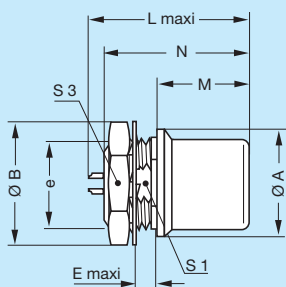

**Fixed socket with key G or keys (code A...M and R), with visible shell**  
**Apparatedose mit Führungsnocke (G) oder Verschlüsselung (Code A...M und R), Befestigung mit Mutter, Körper vorstehend**

Reference		Dimensions (mm)								
Model	Series	A	B	e	E	L	M	N	S1	S3
EHG	00	8.8	10.3	M7x0.5	2.0	15.5	8.5	13.7	6.3	9
EHG	0B	10	12.5	M9x0.6	2.5	19.5	12.5	19.1	8.2	11
EHG	1B	14	16.0	M12x 1	4.2	21.7	12.5	20.8	10.5	14
EHG	2B	18	19.5	M15x 1	5.2	22.7	12.5	24.3	13.5	17

P1 Panel cut out: see Unipole/Multipole catalogue  
 Bohrplan der Frontplatte: siehe Unipole/Multipole Katalog

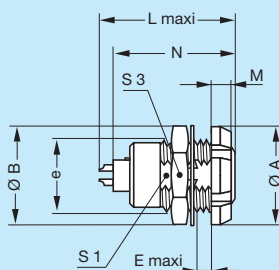

**Fixed socket with two fixing nuts, with key G or keys (code A...M and R), (back panel mounting)**  
**Apparatedose mit Führungsnocke (G) oder Verschlüsselung (Code A...M und R), Befestigung mit Mutter (von der Rückseite der Frontplatte montierbar)**

Reference		Dimensions (mm)								
Model	Series	A	B	e	E	L	M	N	S1	S3
ECG	00	10	9.5	M7x0.5	4.3	13.7	2.5	13.7	6.3	9
EGG	0B	12	12.5	M9x0.6	5.5	19.5	2.5	17.5	8.2	11
ECG	1B	16	16	M12x 1	6.0	21.7	3.2	19.5	10.5	14
ECG	2B	20	19.5	M15x 1	6.5	25.0	3.8	21.5	13.5	17

P1 Panel cut out: see Unipole/Multipole catalogue  
 Bohrplan der Frontplatte: siehe Unipole/Multipole Katalog

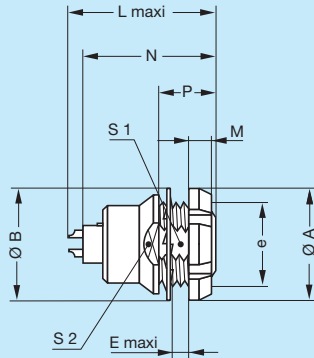

Fixed socket with key G or keys (code A...M and R),  
(back panel mounting)  
Apparatedose mit Führungsnocke (G) oder  
Verschlüsselung (Code A...M und R),  
Befestigung mit Mutter,  
(von der Rückseite der Frontplatte montierbar)

Reference		Dimensions (mm)									
Model	Series	A	B	e	E	L	M	N	P	S1	S3
EEG	00	10	9.5	M7x0.5	2.3	15.5	2.5	13.7	6.0	6.3	7.5
EEG	0B	12	12.5	M9x0.6	2.4	20.7	2.5	19.1	6.3	8.2	9.0
EEG	1B	16	16.0	M12x 1	6.0	23.0	3.5	21.1	11.0	10.5	13.0
EEG	2B	20	20.0	M15x 1	4.2	26.7	3.5	24.6	9.0	13.5	15.0

P1 Panel cut out: see Unipole/Multipole catalogue  
Bohrplan der Frontplatte: siehe Unipole/Multipole Katalog

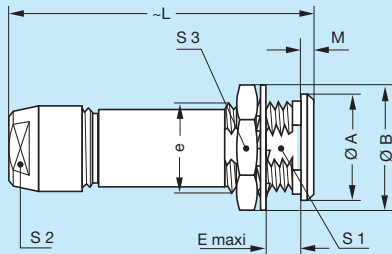

Fixed socket, nut fixing, with key G or keys  
(code A...M and R), cable collet  
Apparatedose, Befestigung mit Mutter,  
mit Führungsnocke (G) oder Verschlüsselung  
(Code A...M und R), Zugentlastung

Reference		Dimensions (mm)								
Model	Series	A	B	e	E	L	M	S1	S2	S3
PKG	00	8	10.3	M7x0.5	6.5	27.0	1.0	6.3	5	9
PKG	0B	10	12.5	M9x0.6	7.0	35.5	1.2	8.2	7	11
PKG	1B	14	16.0	M12x 1	7.5	40.5	1.5	10.5	9	14
PKG	2B	18	19.5	M15x 1	8.5	47.0	1.8	13.5	12	17

M1 Assembly instruction: see Unipole/Multipole catalogue  
Montageanweisungen: siehe Unipole/Multipole Katalog



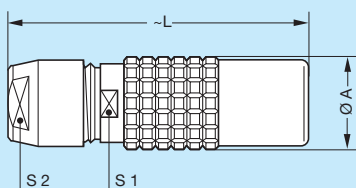







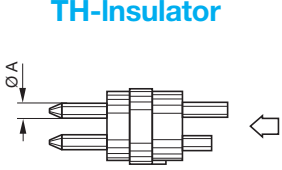















P1 Panel cut out: see Unipole/Multipole catalogue  
Bohrplan der Frontplatte: siehe Unipole/Multipole Katalog



Free socket, with key G or keys (code A...M and R), cable collet  
Kupplung mit Führungsnocke (G)  
oder Verschlüsselung (Code A...M und R),  
Zugentlastung

Reference		Dimensions (mm)			
Model	Series	A	L	S1	S2
PHG	00	6.4	27	5.5	5
PHG	0B	9.5	35	8	7
PHG	1B	12.5	40	10	9
PHG	2B	16.5	47	13	12

M1 Assembly instruction: see Unipole/Multipole catalogue  
Montageanweisungen: siehe Unipole/Multipole Katalog

			Reference	Series	Number of contacts	Contact-Ø Ø A (mm)	Max. Conductor-Ø	Contact-No.	Thermo contact-Type					
Size	FGG	EGG							E	J	K	T	L	W
00			302	00	2	0.5	0.4	1 2	-	-	-	-	LP LN	W W
			303	00	3	0.5	0.4	1 2 3	-	-	-	-	LP LN L	W W W
0B			302	0B	2	0.9	0.8	1 2	EP EN	JP JN	KP KN	TP TN	LP LN	W W
			303	0B	3	0.9	0.8	1 2 3	EP EN L	JP JN L	KP KN L	TP TN L	LP LN L	W W W
			902	0B	4	0.7	0.6	1-3 2-4	EP EN	JP JN	KP KN	TP TN	LP LN	W W
1B			302	1B	2	1.3	1.0	1 2	EP EN	JP JN	KP KN	TP TN	LP LN	W W
			303	1B	3	1.3	1.0	1 2 3	EP EN L	JP JN L	KP KN L	TP TN L	LP LN L	W W W
			902	1B	4	0.9	0.8	1-3 2-4	EP EN	JP JN	KP KN	TP TN	LP LN	W W
			903	1B	6	0.7	0.6	1-3-5 2-4-6	EP EN	JP JN	KP KN	TP TN	LP LN	W W
2B			302	2B	2	2.0	1.8	1 2	EP EN	JP JN	KP KN	TP TN	LP LN	W W
			303	2B	3	1.6	1.4	1 2 3	EP EN L	JP JN L	KP KN L	TP TN L	LP LN L	W W W
			902	2B	4	1.3	1.0	1-3 2-4	EP EN	JP JN	KP KN	TP TN	LP LN	W W
			903	2B	6	1.3	1.0	1-3-5 2-4-6	EP EN	JP JN	KP KN	TP TN	LP LN	W W

**Bestellbeispiel**  
 Isolationssteile: FGG.0B.302.ZLK  
 EGG.0B.302.ZLK  
 Stecker: FGG.0B.302.CLK  
 Apparatedose: EGG.0B.302.CLK  
 Kupplung: PHG.0B.302.CLK

**Part number example**  
 Insulator: FGG.0B.302.ZLK  
 EGG.0B.302.ZLK  
 Plug: FGG.0B.302.CLK  
 Fixed socket: EGG.0B.302.CLK  
 Free socket: PHG.0B.302.CLK

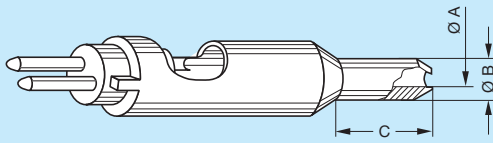

Part number Collet	Reference		Series	Dimensions of the collet (mm)			Ø Thermo- couple max. (mm)	Part number Insulator	Part number Collet/Insulator, fitted	Time of delivery
	Model	Ø		ØA	ØB	C				
FGG.0B.706.NN	N	06	0B	0.6	4.5	6.3	0.55	2-polig: FGG.0B.302.ZLA 3-polig: FGG.0B.303.ZLA 4-polig: FGG.0B.304.ZLA	FGG.0B.30..ZLAN06	○
FGG.0B.712.NN	N	12		1.2	4.5	6.3	1.15		FGG.0B.30..ZLAN12	○
FGG.0B.716.NN	N	16		1.6	4.5	6.3	1.55		FGG.0B.30..ZLAN16	●
FGG.0B.721.NN	N	21		2.1	4.5	6.3	2.05		FGG.0B.30..ZLAN21	○
FGG.0B.726.NN	N	26		2.6	4.5	6.3	2.55		FGG.0B.30..ZLAN26	●
FGG.0B.730.NN	N	30		3.0	4.5	6.3	2.95		FGG.0B.30..ZLAN30	○
FGG.0B.733.NN	N	33		3.3	4.5	6.3	3.25		FGG.0B.30..ZLAN33	●
FGG.0B.749.NN	N	49		4.9	5.5	7.5	4.85		FGG.0B.30..ZLAN49	○
FGG.1B.721.NN	N	21	1B	2.1	7.0	6.0	2.05	2-polig: FGG.1B.302.ZLA 3-polig: FGG.1B.303.ZLA 4-polig: FGG.1B.304.ZLA	FGG.1B.30..ZLAN21	○
FGG.1B.726.NN	N	26		2.6	7.0	6.0	2.55		FGG.1B.30..ZLAN26	●
FGG.1B.733.NN	N	33		3.3	7.0	6.0	3.25		FGG.1B.30..ZLAN33	○
FGG.1B.749.NN	N	49		4.9	7.0	6.0	4.85		FGG.1B.30..ZLAN49	○
FGG.1B.766.NN	N	66		6.6	7.0	6.0	6.55		FGG.1B.30..ZLAN66	○
FGG.2B.733.NN	N	33	2B	3.3	6.5	6.0	3.25	2-polig: FGG.2B.302.ZLA 3-polig: FGG.2B.303.ZLA 4-polig: FGG.2B.304.ZLA	FGG.2B.30..ZLAN33	○
FGG.2B.749.NN	N	49		4.9	6.5	6.0	4.85		FGG.2B.30..ZLAN49	●
FGG.2B.766.NN	N	66		6.6	9.0	8.5	6.55		FGG.2B.30..ZLAN66	○
FGG.2B.781.NN	N	81		8.1	9.0	8.5	8.05		FGG.2B.30..ZLAN81	○
FGG.2B.797.NN	N	97		9.7	10.5	10	9.65		FGG.2B.30..ZLAN97	○

- auf Lager  
(Lieferzeit je nach Lagerbestand)
- Auftragsfertigung im Werk

Bestellbeispiel:  
FGG.0B.302.ZLAN06

- in stock  
(delivery time depends of stock)
- order in production

Part number example:  
FGG.0B.302.ZLAN06

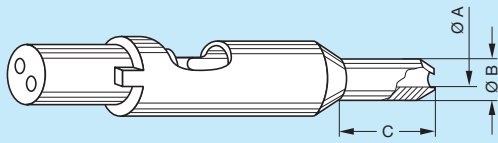

Part number Collet	Reference		Series	Dimensions of the collet (mm)			Ø Thermo- couple max. (mm)	Part number Insulator	Part number Collet/Insulator, fitted	Time of delivery
	Model	Ø		ØA	ØB	C				
PHG.0B.706.NN	N	06	0B	0.6	4.5	6.3	0.55	2-polig: PHG.0B.302.ZLL	PHG.0B.30●.ZLLN06	●
PHG.0B.712.NN	N	12		1.2	4.5	6.3	1.15		PHG.0B.30●.ZLLN12	○
PHG.0B.716.NN	N	16		1.6	4.5	6.3	1.55	3-polig: PHG.0B.303.ZLL	PHG.0B.30●.ZLLN16	○
PHG.0B.721.NN	N	21		2.1	4.5	6.3	2.05		PHG.0B.30●.ZLLN21	○
PHG.0B.726.NN	N	26		2.6	4.5	6.3	2.55	4-polig: PHG.0B.304.ZLL	PHG.0B.30●.ZLLN26	●
PHG.0B.733.NN	N	33		3.3	4.5	6.3	3.25		PHG.0B.30●.ZLLN33	●
PHG.0B.749.NN	N	49		4.9	5.5	7.5	4.85	PHG.0B.30●.ZLLN49	○	
PHG.1B.721.NN	N	21	1B	2.1	7.0	6.0	2.05	2-polig: PHG.1B.302.ZLL	PHG.1B.30●.ZLLN21	●
PHG.1B.726.NN	N	26		2.6	7.0	6.0	2.55		PHG.1B.30●.ZLLN26	●
PHG.1B.733.NN	N	33		3.3	7.0	6.0	3.25	3-polig: PHG.1B.303.ZLL	PHG.1B.30●.ZLLN33	○
PHG.1B.749.NN	N	49		4.9	7.0	6.0	4.85		PHG.1B.30●.ZLLN49	○
PHG.1B.766.NN	N	66		6.6	7.0	6.0	6.55	4-polig: PHG.1B.304.ZLL	PHG.1B.30●.ZLLN66	○
PHG.2B.733.NN	N	33	2B	3.3	6.5	6.0	3.25	2-polig: PHG.2B.302.ZLL	PHG.2B.30●.ZLLN33	○
PHG.2B.749.NN	N	49		4.9	6.5	6.0	4.85		PHG.2B.30●.ZLLN49	○
PHG.2B.766.NN	N	66		6.6	9.0	8.5	6.55	3-polig: PHG.2B.303.ZLL	PHG.2B.30●.ZLLN66	○
PHG.2B.781.NN	N	81		8.1	9.0	8.5	8.05		4-polig: PHG.2B.304.ZLL	PHG.2B.30●.ZLLN81

- auf Lager  
(Lieferzeit je nach Lagerbestand)
- Auftragsfertigung im Werk

Bestellbeispiel:  
PHG.0B.302.ZLLN06

- in stock  
(delivery time depends of stock)
- order in production

Part number example:  
PHG.0B.302.ZLLN06

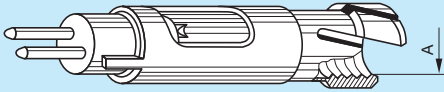

Part number Collet	Reference		Series	Dimensions of the collet (mm)			Ø Thermo- couple max. (mm)	Part number Insulator	Part number Collet/Insulator, fitted	Time of delivery							
	Model	Ø		ØA	ØB	C											
FGG.0B.721.FN	F	21	0B	2.1	-	-	2.0	2-polig: FGG.0B.302.ZLA: 3-polig: FGG.0B.303.ZLA 4-polig: FGG.0B.304.ZLA	FGG.0B.30..ZLAF21	○							
FGG.0B.731.FN	F	31		3.1	-	-	3.0				3-polig: FGG.0B.303.ZLA 4-polig: FGG.0B.304.ZLA	FGG.0B.30..ZLAF31	○				
FGG.0B.742.FN	F	42		4.2	-	-	4.0							FGG.0B.30..ZLAF42	○		
FGG.0B.752.FN	F	52		5.2	-	-	5.0									FGG.0B.30..ZLAF52	○
FGG.1B.727.FN	F	27	1B	2.7	-	-	2.5	2-polig: FGG.1B.302.ZLA 3-polig: FGG.1B.303.ZLA 4-polig: FGG.1B.304.ZLA	FGG.1B.30..ZLAF27	○							
FGG.1B.731.FN	F	31		3.1	-	-	3.0				3-polig: FGG.1B.303.ZLA 4-polig: FGG.1B.304.ZLA	FGG.1B.30..ZLAF31	○				
FGG.1B.742.FN	F	42		4.2	-	-	4.0							FGG.1B.30..ZLAF42	○		
FGG.1B.752.FN	F	52		5.2	-	-	5.0									FGG.1B.30..ZLAF52	○
FGG.1B.762.FN	F	62		6.2	-	-	6.0										
FGG.2B.731.FN	F	31	2B	3.1	-	-	3.0	2-polig: FGG.2B.302.ZLA 3-polig: FGG.2B.303.ZLA 4-polig: FGG.2B.304.ZLA	FGG.2B.30..ZLAF31	○							
FGG.2B.752.FN	F	52		5.2	-	-	5.0				3-polig: FGG.2B.303.ZLA 4-polig: FGG.2B.304.ZLA	FGG.2B.30..ZLAF52	○				
FGG.2B.772.FN	F	72		7.2	-	-	7.0							FGG.2B.30..ZLAF72	○		
FGG.2B.782.FN	F	82		8.2	-	-	8.0									FGG.2B.30..ZLAF82	○
FGG.2B.799.FN	F	99		9.9	-	-	8.0										

- auf Lager  
(Lieferzeit je nach Lagerbestand)
- Auftragsfertigung im Werk

Bestellbeispiel:  
FGG.0B.302.ZLAF21

- in stock  
(delivery time depends of stock)
- order in production

Part number example:  
FGG.0B.302.ZLAF21



**Konfektionierungs-Beispiel  
NiCr-Ni (Chromel-Alumel)**

**Cable assembly example  
NiCr-Ni (Chromel-Alumel)**

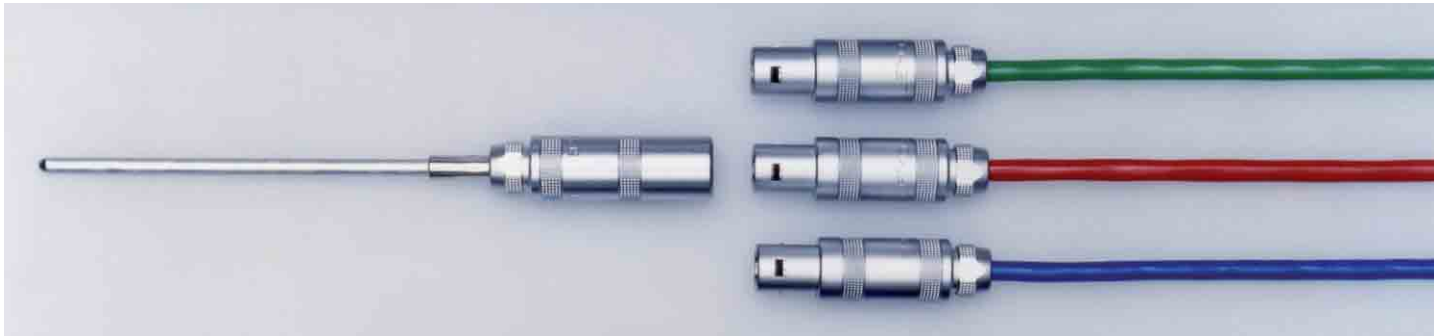

**Configuration**

**Kontaktanordnung**

Nr. Code	Material	Material	Polarität Polarity	Lieferzeit Delivery
E	Ni-Cr Ko	Chromel Constantan	EP(+) EN(-)	○
J	Fe Ko	Iron Constantan	JP(+) JN(-)	○
K	Ni-Cr Ni	Chromel Alumel	KP(+) KN(-)	○
L	Messing Bronze	Brass Bronze	LP(+) LN(-)	●
T	Cu Ko	Copper Constantan	TP(+) TN(-)	○
W	Cu Cu	Copper Copper	W W	○

N = Pole negative (-) P = Pole positive (+) L = Standard contact gold plated  
N = Pol Negativ (-) P = Pol Positiv (+) L = Standardkontakt vergoldet

Siehe auch Tabelle TH-Kontaktanordnung: S Serie: Seite 18, B Serie: Seite 37  
See also table TH-Contact figuration: S Series: page 18, B Series: page 37

**Colorindication Iso-S Series  
Farbmarkierung Iso-S Serie**

FFA = Yellow number / gelbe Nummer

PCA }  
PSA } = White number / weiße Nummer  
ERA }

**Magnetic pole formation  
Magnetische Polanordnung**

Thermo material / Thermomaterial:

NiCr-Ni + Pole red, non magnetic / + Pol rot, antimagnetisch  
(Chromel-Alumel) - Pole green, magnetic / Pol grün, magnetisch

Compensation material / Ausgleichsmaterial:

Fe-CuNi + Pole red, non magnetic / + Pol rot, antimagnetisch  
- Pole green, magnetic / Pol grün, magnetisch

**Beispiel: Kontaktanordnung  
NiCr-Ni (Chromel-Alumel)**

**Example: Configuration  
NiCr-Ni (Chromel-Alumel)**

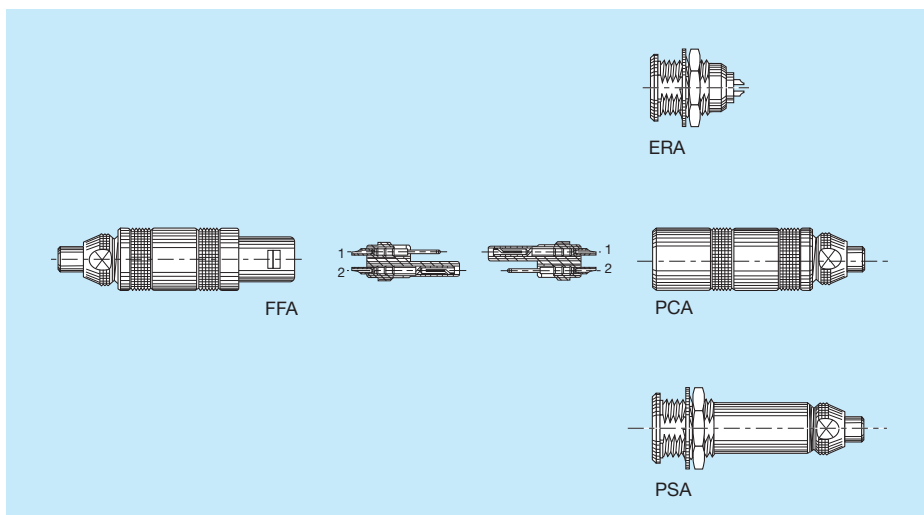

## Insulators for Crimpcontacts Isolationsteile für Crimpkontakte

### Male insulator Isolationsteil männlich

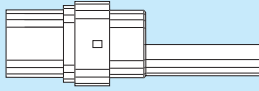

Male insulators are yellow numbered.  
Männliche Isolationsteile sind gelb nummeriert.

### Female insulator Isolationsteil weiblich

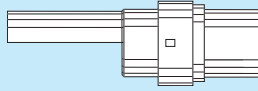

Female insulators are white numbered.  
Weibliche Isolationsteile sind weiß nummeriert.

### Fixed socket without contacts Apparatedose ohne Kontakte

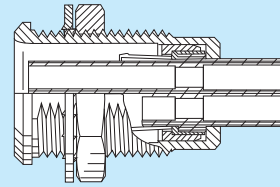

Series	Reference	Insulator part number		Fixed socket without contacts	Lead time
		Male	Female		
0S 0E	302	FFA.0S.302.ZYZ	PSA.0S.302.ZYZ	ERA.0S.302.CLZ	●
	303	FFA.0S.303.ZYZ	PSA.0S.303.ZYZ	ERA.0S.303.CLZ	○
	304	FFA.0S.304.ZYZ	PSA.0S.304.ZYZ	ERA.0S.304.CLZ	●
1S 1E	302	FFA.1S.302.ZYZ	PSA.1S.302.ZYZ	ERA.1S.302.CLZ	●
	303	FFA.1S.303.ZYZ	PSA.1S.303.ZYZ	ERA.1S.303.CLZ	○
	304	FFA.1S.304.ZYZ	PSA.1S.304.ZYZ	ERA.1S.304.CLZ	●
	305	FFA.1S.305.ZYZ	PSA.1S.305.ZYZ	ERA.1S.305.CLZ	○
	306	FFA.1S.306.ZYZ	PSA.1S.306.ZYZ	ERA.1S.306.CLZ	○
2S 2E	302	FFA.2S.302.ZYZ	PSA.2S.302.ZYZ	ERA.2S.302.CLZ	○
	303	FFA.2S.303.ZYZ	PSA.2S.303.ZYZ	ERA.2S.303.CLZ	○
	304	FFA.2S.304.ZYZ	PSA.2S.304.ZYZ	ERA.2S.304.CLZ	○
	305	FFA.2S.305.ZYZ	PSA.2S.305.ZYZ	ERA.2S.305.CLZ	○
	306	FFA.2S.306.ZYZ	PSA.2S.306.ZYZ	ERA.2S.306.CLZ	○
	307	FFA.2S.307.ZYZ	PSA.2S.307.ZYZ	ERA.2S.307.CLZ	○
	308	FFA.2S.308.ZYZ	PSA.2S.308.ZYZ	ERA.2S.308.CLZ	○
	310	FFA.2S.310.ZYZ	PSA.2S.310.ZYZ	ERA.2S.310.CLZ	○

● on stock ○ request

## Crimpcontacts – standard Crimpkontakte – Standard

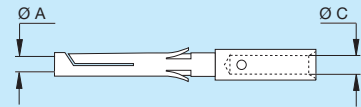
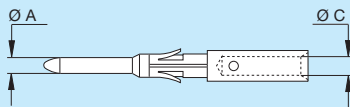

Series	Reference	Ø A (mm)	Ø C (mm)	Contact part number	
				Male	Female
0S 0E	302	0,9	1,1	FGG.0B.560.ZZC	EGG.0B.660.ZZM
	303/304	0,7	0,8	FGG.0B.555.ZZC	EGG.0B.655.ZZM
1S 1E	302	1,3	1,4	FGG.1B.565.ZZC	EGG.1B.665.ZZM
	303/304	0,9	1,1	FGG.1B.560.ZZC	EGG.1B.660.ZZM
	305	0,9	1,1	FGG.1B.560.ZZC	EGG.1B.660.ZZM
		0,7	0,8	FGG.1B.555.ZZC	EGG.1B.655.ZZM
	306	0,7	0,8	FGG.1B.555.ZZC	EGG.1B.655.ZZM
2S 2E	302	1,6	1,9	FGG.2B.570.ZZC	EGG.2B.670.ZZM
	303/304	1,3	1,4	FGG.2B.565.ZZC	EGG.2B.665.ZZM
	305/306				
	307	1,3	1,4	FGG.2B.565.ZZC	EGG.2B.665.ZZM
		0,9	1,1	FGG.2B.560.ZZC	EGG.2B.660.ZZM
	308/310	0,9	1,1	FGG.2B.560.ZZC	EGG.2B.660.ZZM

**TH-material mark (groove)**  
**Markierung der TH-Materialien (Rillen)**

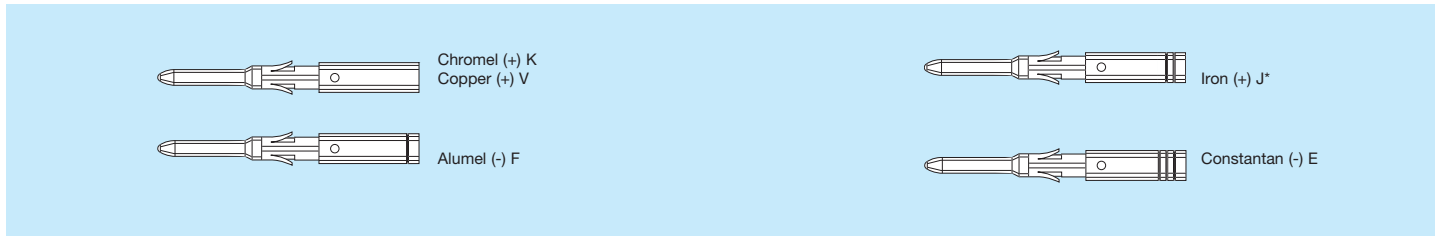

\* Auf Anfrage    \* on request

**Crimpcontacts – TH-material**  
**Crimpkontakte – TH-Material**

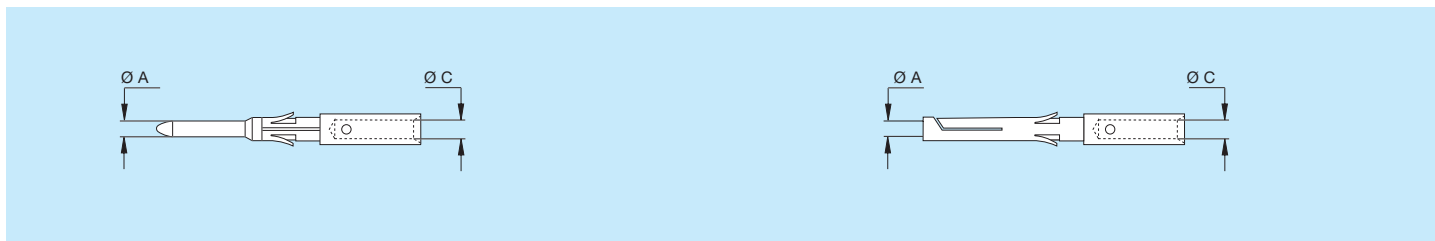

Series	Reference	Ø A (mm)	Ø C (mm)	Male	Female	TH-Material
0S 0E	302	0,9	1,1	FGG.0B.560.ZZK	EGG.0B.660.ZZK	NiCr (Chromel) (+)
		0,9	1,1	FGG.0B.560.ZZF	EGG.0B.660.ZZF	Ni (Alumel) (-)
		0,9	1,1	FGG.0B.560.ZZV	EGG.0B.660.ZZV	Cu (Copper) (+)
		0,9	1,1	FGG.0B.560.ZZE	EGG.0B.660.ZZE	CuNi (Constantan) (-)
	303/304	0,7	0,8	FGG.0B.555.ZZK	EGG.0B.655.ZZK	NiCr (Chromel) (+)
		0,7	0,8	FGG.0B.555.ZZF	EGG.0B.655.ZZF	Ni (Alumel) (-)
		0,7	0,8	FGG.0B.555.ZZV	EGG.0B.655.ZZV	Cu (Copper) (+)
		0,7	0,8	FGG.0B.555.ZZE	EGG.0B.655.ZZE	CuNi (Constantan) (-)
1S 1E	302	1,3	1,4	FGG.1B.565.ZZK	EGG.1B.665.ZZK	NiCr (Chromel) (+)
		1,3	1,4	FGG.1B.565.ZZF	EGG.1B.665.ZZF	Ni (Alumel) (-)
		1,3	1,4	FGG.1B.569.ZZV	EGG.1B.665.ZZV	Cu (Copper) (+)
		1,3	1,4	FGG.1B.565.ZZE	EGG.1B.665.ZZE	CuNi (Constantan) (-)
	306	0,7	0,8	FGG.1B.555.ZZK	EGG.1B.655.ZZK	NiCr (Chromel) (+)
		0,7	0,8	FGG.1B.555.ZZF	EGG.1B.655.ZZF	Ni (Alumel) (-)

Insulators with crimp contacts  
(in the double pack)

Isolationsteile mit Crimpkontakten  
(im Doppelpack)



Type: K

Type: E

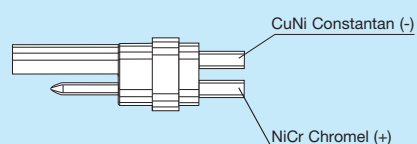
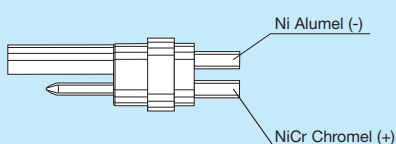
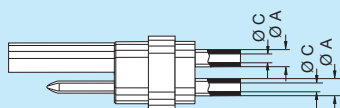

Series	Reference	Ø A (mm)	Ø C (mm)	Order number	Contact material (TH-material)	Crimping tool
0S 0E	302	1,3	0,4	PSA.0S.302.ZLM1	standard gold contacts	DPE.91.121.2K
		1,3	0,7	PSA.0S.302.ZLM2	standard gold contacts	
		0,9	0,3	PSA.0S.302.ZLM4	standard gold contacts	DPE.91.111.1K
1S 1E	302	1,6	0,7	PSA.1S.302.ZLM1	standard gold contacts1S	DPE.99.171.1K
		1,6	0,4	PSA.1S.302.ZLM2	standard gold contacts	
		1,6	0,6	PSA.1S.302.ZLM3	standard gold contacts	
0S 0E	302	1,3	0,4	PSA.0S.302.ZLM1K	NiCr Chromel (+); Ni Aludel (-)	DPE.91.121.2K
				PSA.0S.302.ZLM1E	NiCr Chromel (+); CuNi Constantan (-)	
1S 1E	302	1,6	0,7	PSA.1S.302.ZLM1K	NiCr Chromel (+); Ni Aludel (-)	DPE.99.171.1K
				PSA.1S.302.ZLM1E	NiCr Chromel (+); CuNi Constantan (-)	

Insulator / Isolationsteil

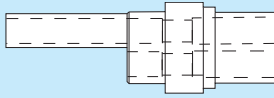

Contacts / Kontakte

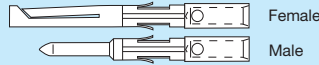

Cable / Kabel

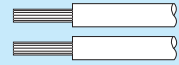

Crimpinfo

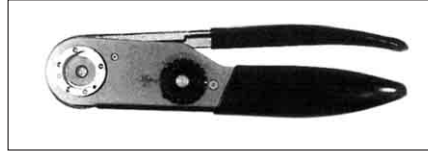

Manual crimping tools / Manuelle Crimp-Werkzeuge

Supplier	Part number	
	contact Ø 0,5-0,7 0,9-1,3 (Fig.1)	contact Ø 1,6-2,0 2,5-3,0 (Fig.2)
LEMO	DPC.91.701.V <sup>1)</sup>	DPC.91.101.A <sup>2)</sup>
DANIELS	MH860 <sup>1)</sup>	AF8 <sup>2)</sup>
ASTRO	616336 <sup>1)</sup>	615708 <sup>2)</sup>

<sup>1)</sup> According to specification MIL-C-22520/7-01.

<sup>2)</sup> According to specification MIL-C-22520/1-01.

Pneumatic crimping tools  
Pneum. Crimp-Werkzeuge

Supplier	Part number
LEMO	DPC.91.701.C
BALMAR	85230
BUCHANAN	621101

According to specification MIL-C-22520/7-01.  
For LEMO contacts Ø 0,5-0,7-0,9-1,3 mm

DCE Positioners for crimp contacts Ø 0,7-0,9 and 1,3 mm  
DCE Positionierer für Crimp-Kontakte mit Ø 0,7-0,9 und 1,3 mm

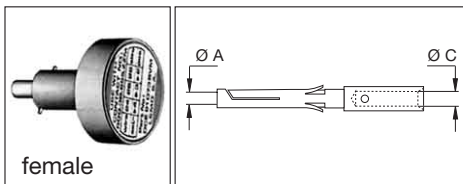
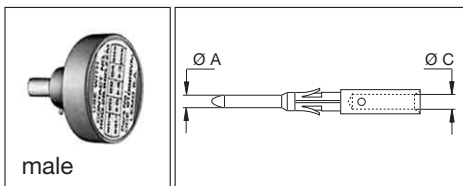

These positioners are suitable for use with both manual and pneumatic crimping tools according to the MIL-C-22520/7-01 standard.

Series	Reference	Ø A (mm)	Ø C (mm)	Conductor AWG	Positioners part number	
					For male contact	For female contact
0S 0E	302	0,9	1,10	20-22-24	DCE.91.090.BVC	DCE.91.090.BVM
	303/304	0,7	0,8	22-24-26	DCE.91.070.BVC	DCE.91.070.BVM
1S 1E	302	1,3	1,40	18-20	DCE.91.131.BVC	DCE.91.131.BVM
	303/304	0,9	1,10	20-22-24	DCE.91.091.BVC	DCE.91.091.BVM
	305	0,9	1,10	20-22-24	DCE.91.071.BVC	DCE.91.071.BVM
		0,7	0,80	22-24-26		
306	0,7	0,80	22-24-26			
2S 2E	303/304	1,3	1,40	18-20	DCE.91.132.BVC	DCE.91.132.BVM
	305/306					
	307	1,3	1,40	18-20	DCE.91.092.BVC	DCE.91.092.BVM
		0,9	1,10	20-22-24		
308/310	0,9	1,10	20-22-24			

DCE Turret for crimp contacts Ø 1,6 mm / DCE Doppelpositionierer für Crimp-Kontakte mit Ø 1,6 mm



Series	Reference	Ø A (mm)	Ø C (mm)	Conductor AWG	Positioners part number
2S 2E	302	1,6	1,90	14-16-18	DCE.91.162.BVCM

Note: these turrets can be used with manual crimping tool according to MIL-C-22520/1-01 standard.

Note: a wide variation of strand number and diameter combinations are quoted as being AWG, some of which do not have a large enough cross section to guarantee a crimp as per either MIL-C-22520/1-01 or /7-01. Our technical department is at your disposal to study and propose a solution to all your applications.

## Automatic-Model

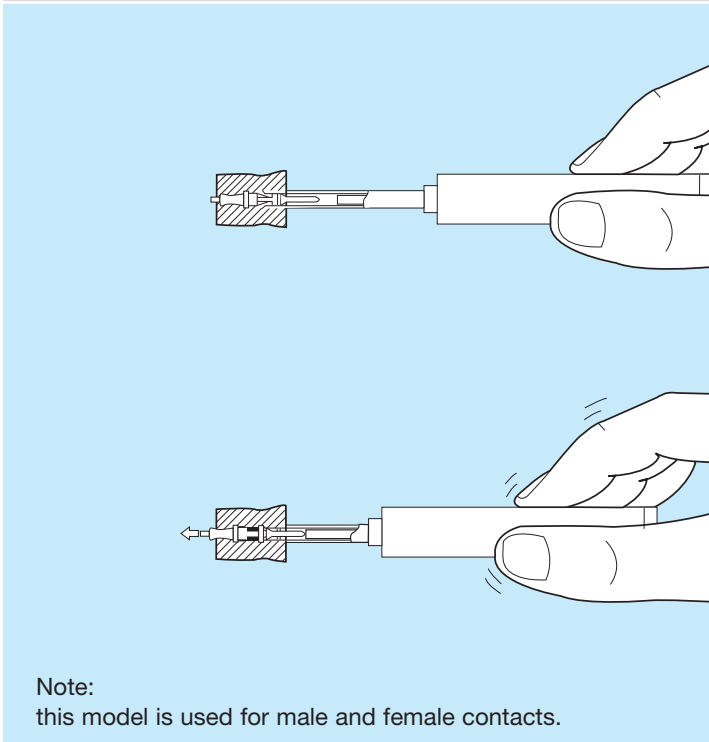
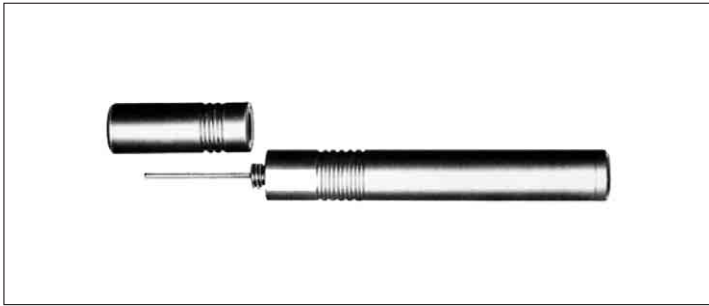

Note:  
this model is used for male and female contacts.

DCF Extraction tools for crimp contact  
DCF Ausstoßwerkzeuge für Crimp-Kontakte

Series	Connector		Extractors part number Automatic model
	Reference	Contact Ø A (mm)	
0S 0E	302	0,9	DCF.91.090.2LT
	303/304	0,7	DCF.91.070.2LT
1S 1E	302	1,3	DCF.91.131.2LT
	303/304	0,9	DCF.91.090.2LT
	305	0,9	DCF.91.070.2LT
		0,7	
306	0,7		
2S 2E	302	1,6	DCF.91.162.2LT
	303/304	1,3	DCF.91.131.2LT
	305/306		
	307	1,3	DCF.91.090.2LT
		0,9	
308/310	0,9		

**Mechanical components from 3B and mechanical components K Series see Unipole/Multipole-Catalogue.**  
**Mechanische Bauteile B Serie ab 3B und mechanische Bauteile K Serie siehe Unipole/Multipole-Katalog.**

**Multipole**

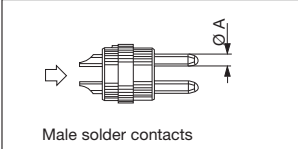
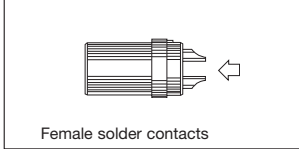
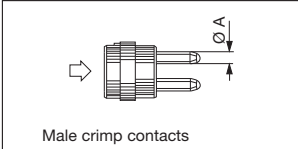
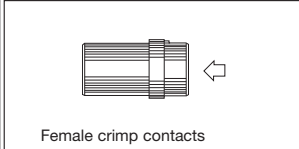
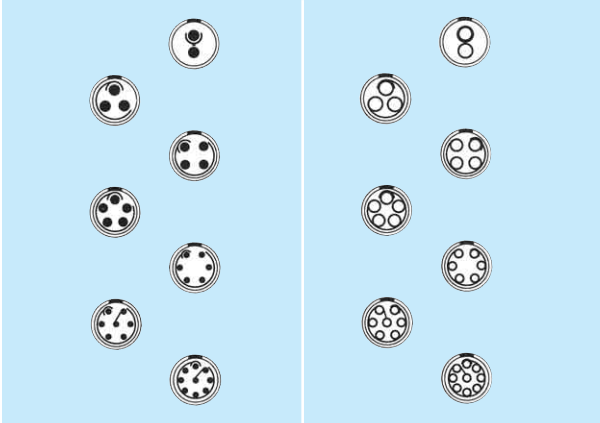
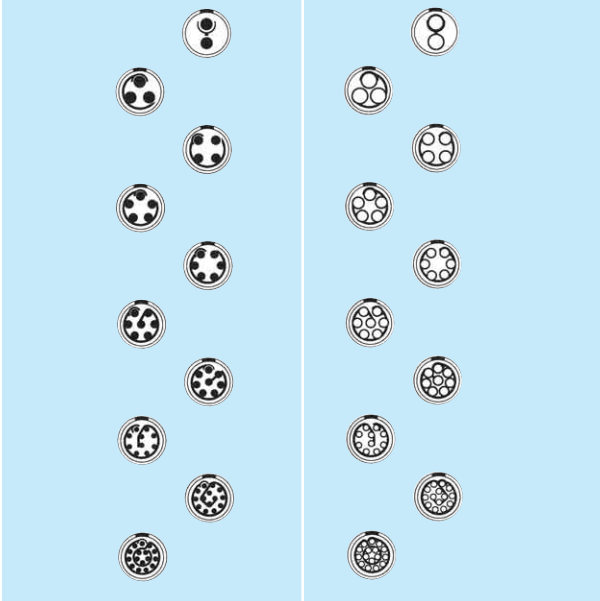









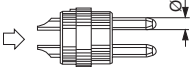
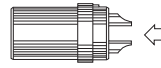
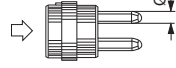

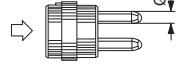

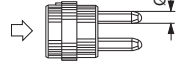

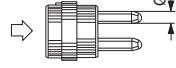

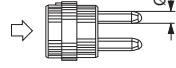

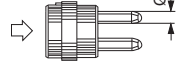

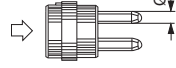

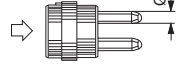

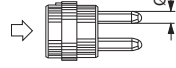

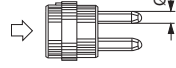
 Male solder contacts  Female solder contacts  Male crimp contacts  Female crimp contacts	Series	Reference	Number of contacts	Ø A (mm)	Contact type				Solder contact		Crimp contact		Rated current (A)
					Solder	Crimp	Print (straight)	Print (elbow)	Test voltage (kW rms) Contact-contact	Test voltage (kW rms) Contact-shell	Test voltage (kW rms) Contact-contact	Test voltage (kW rms) Contact-shell	
	0B OK	302	2	0,9	●	●	●	●	1,30	1,05	1,45	1,20	10,0
		303	3	0,9	●	●	●	●	1,20	0,90	1,70	1,60	8,0
		304 <sup>1)</sup>	4	0,7	●	●	●	●	0,85	0,70	1,35	1,10	7,0
		305	5	0,7	●	●	●	●	1,00	0,70	1,25	1,20	6,5
		306	6	0,5	●	●	●	●	0,85	0,65	1,40	1,20	2,5
		307	7	0,5	●	●	●	●	0,80	0,70	1,40	1,20	2,5
		309	9	0,5	●	●	○	○	0,60	0,50	1,00	0,85	2,0
	1B 1K	302	2	1,3	●	●	●	●	1,50	1,35	1,70	1,45	15,0
		303	3	1,3	●	●	●	●	1,30	1,55	1,60	1,85	12,0
		304	4	0,9	●	●	●	●	1,35	1,45	1,70	1,80	10,0
		305	5	0,9	●	●	●	●	1,25	1,15	1,30	1,55	9,0
		306	6	0,7	●	●	●	●	1,05	1,20	1,35	1,45	7,0
		307	7	0,7	●	●	●	●	0,95	1,05	1,45	1,45	7,0
		308	8	0,7	●	●	●	●	0,95	1,15	1,30	1,30	5,0
		310	10	0,5	●	●	●	●	0,90	1,50	1,20	1,80	2,5
		314	14	0,5	●	●	●	●	0,80	1,20	0,95	1,60	2,0
		316	16	0,5	●	●	●	○	0,80	1,25	0,95	1,60	1,5

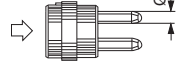
<sup>1)</sup> Also available with ceramic insulator (crimp only)

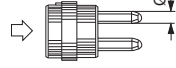
Auch mit Keramik-Isolationsteil verfügbar (nur Crimpversion)

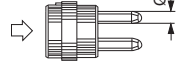
● First choice alternative  
○ Special order alternative

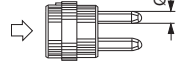
## Multipole

Male solder contacts	Female solder contacts	Series	Reference	Number of contacts	Ø A (mm)	Contact type				Solder contact		Crimp contact		Rated current (A)
						Solder	Crimp	Print (straight)	Print (elbow)	Test voltage (kW rms) Contact-contact	Test voltage (kW rms) Contact-shell	Test voltage (kW rms) Contact-contact	Test voltage (kW rms) Contact-shell	
		2B 2K	302	2	2,0	●	●	●	○	2,10	1,75	2,85	2,70	30,0
			303	3	1,6	●	●	●	●	2,40	1,85	1,90	1,90	17,0
			304	4	1,3	●	●	●	●	1,85	1,85	2,20	2,20	15,0
			305	5	1,3	●	●	●	●	1,75	1,60	2,15	2,15	14,0
			306	6	1,3	●	●	●	●	1,35	1,45	2,00	2,35	12,0
			307	7	1,3	●	●	●	●	1,75	1,60	1,95	2,15	11,0
			308	8	0,9	●	●	●	●	1,50	1,25	1,95	1,95	10,0
			310	10	0,9	●	●	●	●	1,45	1,30	1,80	2,10	8,0
			312	12	0,7	●	●	●	●	1,25	1,35	1,65	2,00	7,0
			314 <sup>1)</sup>	14	0,7	●	●	●	●	1,15	1,35	1,55	1,95	6,5
			316	16	0,7	●	●	●	●	0,95	1,25	1,55	1,75	6,0
			318	18	0,7	●	●	●	●	0,85	1,20	1,45	2,10	5,5
			319	19	0,7	●	●	●	●	0,95	1,25	1,55	1,65	5,0
			326	26	0,5	●	●	○	-	0,95	1,30	1,20	1,80	2,0
			332	32	0,5	●	●	○	-	0,80	1,2	0,95	1,60	1,5

From 3B/3K Series see Unipole/Multipole-Catalogue.  
Ab 3B/3K Serie siehe Unipole/Multipole-Katalog.

● First choice alternative  
○ Special order alternative

<sup>1)</sup> Also available with ceramic insulator (crimp only)  
Auch mit Keramik-Isolationsteil verfügbar (nur Crimpversion)



**FGG-EGG Crimp contacts**

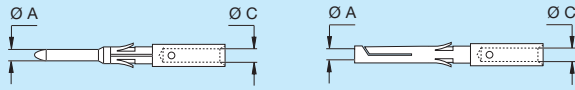

Fig.1

Series	Reference	Ø A (mm)	Ø C (mm)	Contact part number	
				Male	Female
0B 0K	302/303	0,9	1,10	FGG.0B.560.ZZC	EGG.0B.660.ZZM
	304/305	0,7	0,80	FGG.0B.555.ZZC	EGG.0B.655.ZZM
	306/307/309	0,5	0,45	FGG.0B.554.ZZC	EGG.0B.654.ZZM
1B 1K	302/303	1,3	1,40	FGG.1B.565.ZZC	EGG.1B.665.ZZM
	304/305	0,9	1,10	FGG.1B.560.ZZC	EGG.1B.660.ZZM
	306/307/308	0,7	0,80	FGG.1B.555.ZZC	EGG.1B.655.ZZM
	310/314/316	0,5	0,45	FGG.1B.554.ZZC	EGG.1B.654.ZZM
2B 2K	302	2,0	2,40	FGG.2B.575.ZZC	EGG.2B.675.ZZM
	303	1,6	1,90	FGG.2B.570.ZZC	EGG.2B.670.ZZM
	304/305	1,3	1,40	FGG.2B.565.ZZC	EGG.2B.665.ZZM
	306/307	1,3	1,40	FGG.2B.565.ZZC	EGG.2B.665.ZZM
	308/310	0,9	1,10	FGG.2B.560.ZZC	EGG.2B.660.ZZM
	312/314/316	0,7	0,80	FGG.2B.555.ZZC	EGG.2B.655.ZZM
	318/319	0,7	0,80	FGG.2B.555.ZZC	EGG.2B.655.ZZM
	326/332	0,5	0,45	FGG.2B.554.ZZC	EGG.2B.654.ZZM

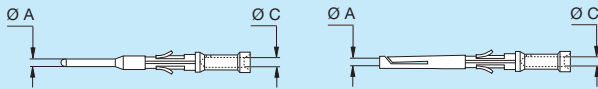
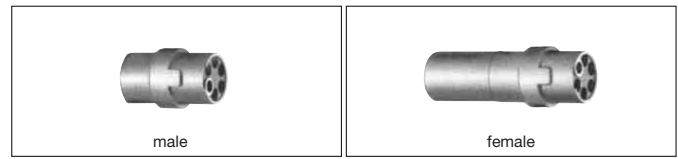

Fig.2

Series	Reference	Ø A (mm)	Ø C (mm)	Contact part number	
				Male	Female
0B 0K	302/303	0,9	0,80	FGG.0B.561.ZZC	EGG.0B.661.ZZM
	302/303	0,9	0,45	FGG.0B.562.ZZC	EGG.0B.662.ZZM
	304/305	0,7	0,45	FGG.0B.556.ZZC	EGG.0B.656.ZZM
1B 1K	302/303	1,3	1,10	FGG.1B.566.ZZC	EGG.1B.666.ZZM
	304/305	0,9	0,80	FGG.1B.561.ZZC	EGG.1B.661.ZZM
	306/307/308	0,7	0,45	FGG.1B.556.ZZC	EGG.1B.656.ZZM
2B 2K	302	2,0	1,90	FGG.2B.576.ZZC	EGG.2B.676.ZZM
	303	1,6	1,40	FGG.2B.571.ZZC	EGG.2B.671.ZZM
	304/305	1,3	1,10	FGG.2B.566.ZZC	EGG.2B.666.ZZM
	306/307	1,3	1,10	FGG.2B.566.ZZC	EGG.2B.666.ZZM
	304/305	1,3	0,80	FGG.2B.567.ZZC	EGG.2B.667.ZZM
	306/307	1,3	0,80	FGG.2B.567.ZZC	EGG.2B.667.ZZM
	308/310	0,9	0,80	FGG.2B.561.ZZC	EGG.2B.661.ZZM
	308/310	0,9	0,45	FGG.2B.562.ZZC	EGG.2B.662.ZZM
	312/314/316	0,7	0,45	FGG.2B.556.ZZC	EGG.2B.656.ZZM
	318/319	0,7	0,45	FGG.2B.556.ZZC	EGG.2B.656.ZZM

From 3B/3K Series see Unipole/Multipole-Catalogue.  
Ab 3B/3K Serie siehe Unipole/Multipole-Katalog.



Series	Reference	Insulator part number	
		Male	Female
0B 0K	302	FGG.0B.302.YL	EGG.0B.402.YL
	303	FGG.0B.303.YL	EGG.0B.403.YL
	304	FGG.0B.304.YL	EGG.0B.404.YL
	304 <sup>1)</sup>	FGG.0B.304.YC	EGG.0B.404.YC
	305	FGG.0B.305.YL	EGG.0B.405.YL
	306	FGG.0B.306.YL	EGG.0B.406.YL
	307	FGG.0B.307.YL	EGG.0B.407.YL
1B 1K	309	FGG.0B.309.YL	EGG.0B.409.YL
	302	FGG.1B.302.YL	EGG.1B.402.YL
	303	FGG.1B.303.YL	EGG.1B.403.YL
	304	FGG.1B.304.YL	EGG.1B.404.YL
	305	FGG.1B.305.YL	EGG.1B.405.YL
	306	FGG.1B.306.YL	EGG.1B.406.YL
	307	FGG.1B.307.YL	EGG.1B.407.YL
	308	FGG.1B.308.YL	EGG.1B.408.YL
	310	FGG.1B.310.YL	EGG.1B.410.YL
	314	FGG.1B.314.YL	EGG.1B.414.YL
	316	FGG.1B.316.YL	EGG.1B.416.YL
2B 2K	302	FGG.2B.302.YL	EGG.2B.402.YL
	303	FGG.2B.303.YL	EGG.2B.403.YL
	304	FGG.2B.304.YL	EGG.2B.404.YL
	305	FGG.2B.305.YL	EGG.2B.405.YL
	306	FGG.2B.306.YL	EGG.2B.406.YL
	307	FGG.2B.307.YL	EGG.2B.407.YL
	308	FGG.2B.308.YL	EGG.2B.408.YL
	310	FGG.2B.310.YL	EGG.2B.410.YL
	312	FGG.2B.312.YL	EGG.2B.412.YL
	314	FGG.2B.314.YL	EGG.2B.414.YL
	314 <sup>1)</sup>	FGG.2B.314.YC	EGG.2B.414.YC
	316	FGG.2B.316.YL	EGG.2B.416.YL
	318	FGG.2B.318.YL	EGG.2B.418.YL
	319	FGG.2B.319.YL	EGG.2B.419.YL
	326	FGG.2B.326.YL	EGG.2B.426.YL
332	FGG.2B.332.YL	EGG.2B.432.YL	

<sup>1)</sup> Ceramic / Keramik  
Technical informations on request  
Technische Informationen auf Anfrage

## TH-material mark (groove)

## Markierung der TH-Materialien (Rillen)

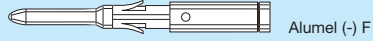
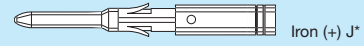
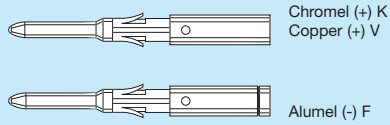

\* Auf Anfrage \* on request

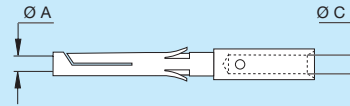
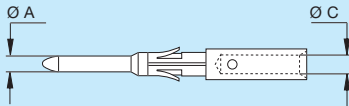
Crimpcontacts – TH-material  
Crimpkontakte – TH-Material

Series	Reference	Ø A (mm)	Ø C (mm)	Male	Female	TH-Material
0B 0K	302/303	0,9	1,1	FGG.0B.560.ZZK	EGG.0B.660.ZZK	NiCr (Chromel) (+)
		0,9	1,1	FGG.0B.560.ZZF	EGG.0B.660.ZZF	Ni (Alumel) (-)
		0,9	1,1	FGG.0B.560.ZZV	EGG.0B.660.ZZV	Cu (Copper) (+)
		0,9	1,1	FGG.0B.560.ZZE	EGG.0B.660.ZZE	CuNi (Constantan) (-)
	304/305	0,7	0,8	FGG.0B.555.ZZK	EGG.0B.655.ZZK	NiCr (Chromel) (+)
		0,7	0,8	FGG.0B.555.ZZF	EGG.0B.655.ZZF	Ni (Alumel) (-)
		0,7	0,8	FGG.0B.555.ZZV	EGG.0B.655.ZZV	Cu (Copper) (+)
		0,7	0,8	FGG.0B.555.ZZE	EGG.0B.655.ZZE	CuNi (Constantan) (-)
1B 1K	302/303	1,3	1,4	FGG.1B.565.ZZK	EGG.1B.665.ZZK	NiCr (Chromel) (+)
		1,3	1,4	FGG.1B.565.ZZF	EGG.1B.665.ZZF	Ni (Alumel) (-)
		1,3	1,4	FGG.1B.569.ZZV	EGG.1B.665.ZZV	Cu (Copper) (+)
		1,3	1,4	FGG.1B.565.ZZE	EGG.1B.665.ZZE	CuNi (Constantan) (-)
	306/307/308	0,7	0,8	FGG.1B.555.ZZK	EGG.1B.655.ZZK	NiCr (Chromel) (+)
		0,7	0,8	FGG.1B.555.ZZF	EGG.1B.655.ZZF	Ni (Alumel) (-)
2B	312/314/316	0,7	0,8	FGG.2B.555.ZZK	EGG.2B.655.TK	NiCr (Chromel) (+)
2K	318/319	0,7	0,8	FGG.2B.555.ZZF	EGG.2B.655.TF	Ni (Alumel) (-)

Please request the appropriate catalog from our marketing department, or directly: [www.lemo.de](http://www.lemo.de)

**Connectors**

- Unipole & Multipole Connectors
- Special cable and fibre optic cable
- F-Series – Harsh Environment Connectors
- Multifunctional connector combinations for the CAMAC-technology
- Connectors, Audio-Video
- P-Series (REDEL)

**Fibre optic connectors**

Monomode and Multimode according to LEMO-Push-Pull-System

**Coaxial Connectors (COELVER)**

**High voltages connectors**  
for the highest reliability in operation

Bitte fordern Sie Ihren entsprechenden Katalog von unserer Marketing-Abteilung an, oder direkt unter: [www.lemo.de](http://www.lemo.de)

**Steckverbindungen**

- Einpolige & mehrpolige Steckverbindungen
- Spezialkabel und LWL-Leitungen
- F-Serie – Für harte Anwendungsgebiete
- Vielseitige Steckkombinationen in der CAMAC-Technik
- Connectors, Audio-Video
- P-Serie (REDEL)

**Glasfaser-Steckverbindungen**

Monomode und Multimode nach dem LEMO-Push-Pull-System

**Coaxial Connectors (COELVER)**

**High voltages connectors**  
mit höchster Betriebssicherheit

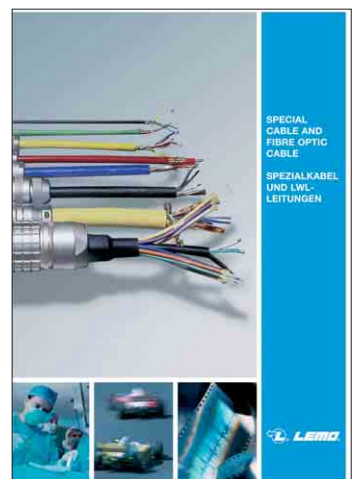

## LEMO HEADQUARTERS

### SWITZERLAND

#### LEMO SA

Chemin des Champs-Courbes 28 - P.O. Box 194 - CH-1024 Ecublens  
Tel. (+41 21) 695 16 00 - Fax (+41 21) 695 16 02 - e-mail: info@lemo.com

## LEMO SUBSIDIARIES

### AUSTRIA

#### LEMO Elektronik GesmbH

Ameisgasse 49-51 / DG1  
1140 Wien  
Tel: (+43 1) 914 23 20 0  
Fax: (+43 1) 911 70 90  
sales@lemo.at

### CHINA

#### LEMO Trading

##### (Shanghai) Co., Ltd.

Rm. 1506,  
Qiangsheng Building  
145 Pujian Road, Pudong  
Shanghai, China, 200127  
Tel: (+86 21) 5039 5366  
Fax: (+86 21) 5039 5266  
cn.sales@lemo.com

### DENMARK

#### LEMO Denmark A/S

Gammel Mosevej 46  
2820 Gentofte  
Tel: (+45) 45 20 44 00  
Fax: (+45) 45 20 44 01  
info-dk@lemo.com

### FRANCE

#### LEMO France Sàrl

165, avenue Jean Jaurès  
94700 Maisons Alfort  
Tel: (+33 1) 45 17 27 90  
Fax: (+33 1) 45 17 27 99  
info-fr@lemo.com

### GERMANY

#### LEMO Elektronik GmbH

Hanns-Schwindt-Str. 6  
81829 München  
Tel: (+49 89) 42 77 03  
Fax: (+49 89) 420 21 92  
info@lemo.de

### HONG KONG

#### LEMO Hong Kong Ltd.

Room 33, 7th Floor  
HITEC, 1 Trademart Drive  
Kowloon Bay - Hong Kong  
Tel: (+852) 21 74 04 68  
Fax: (+852) 21 74 04 92  
hk.sales@lemo.com

### HUNGARY

#### REDEL Elektronika Kft

Vágóhíd u. 26  
1201 Budapest XX.  
Tel: (+36 1) 421 47 10  
Fax: (+36 1) 421 47 57  
info-hu@lemo.com

### ITALY

#### LEMO Italia srl

Viale Lunigiana 25  
20125 Milano  
Tel: (+39 02) 66 71 10 46  
Fax: (+39 02) 66 71 10 66  
sales.it@lemo.com

## LEMO DISTRIBUTORS

AUSTRALIA, BRAZIL, CANADA, CZECH REPUBLIC, GREECE, INDIA, ISRAEL,  
MALAYSIA, NEW ZEALAND, PHILIPPINES, POLAND, RUSSIA, SINGAPORE,  
SOUTH AFRICA, SOUTH KOREA, TAIWAN, THAILAND, TURKEY, UKRAINE

[www.lemo.com](http://www.lemo.com)

### JAPAN

#### LEMO Japan Ltd

KRD Bldg. 4F, 1-13-1,  
Mukogaoka, Bunkyo-ku,  
Tokyo, 113-0023  
Tel: (+81 3) 38 11 21 61  
Fax: (+81 3) 38 11 21 67  
lemoinfo@lemo.co.jp

### NETHERLANDS / BELGIUM

#### LEMO Connectors

Nederland B.V.  
De Trompet 1860  
1967DB Heemskerk  
Tel: (+31 0) 251 78 31 51  
Fax: (+31 0) 251 78 31 50  
info-nl@lemo.com

### NORWAY / ICELAND

#### LEMO Norway A/S

Stanseveien 6B  
0975 Oslo  
Tel: (+47) 22 91 70 40  
Fax: (+47) 22 91 70 41  
info-no@lemo.com

### SPAIN / PORTUGAL

#### IBERLEMO S.A.

Brasil, 45, 08402 Granollers  
Barcelona  
Tel: (+34 93) 860 44 20  
Fax: (+34 93) 879 10 77  
info-es@lemo.com

### SWEDEN / FINLAND

#### LEMO Nordic AB

Mariehällsvägen 39A  
168 65 Bromma  
Tel: (+46 8) 635 60 60  
Fax: (+46 8) 635 60 61  
info-se@lemo.com

### SWITZERLAND

#### LEMO Verkauf AG

Grundstrasse 22 B  
6343 Rotkreuz  
Tel: (+41 41) 790 49 40  
Fax: (+41 41) 790 49 43  
ch.sales@lemo.com

### UNITED KINGDOM

#### LEMO UK Ltd

Unit 15 & 16  
Hazelwood Trading Estate  
Worthing  
West Sussex, BN14 8NP  
Tel: (+44 1903) 23 45 43  
Fax: (+44 1903) 20 62 31  
lemo-uk@lemo.com

### USA

#### LEMO USA Inc

P.O. Box 2408  
Rohnert Park  
CA 94927-2408  
Tel: (+1 707) 578 88 11  
(+1 800) 444 53 66  
Fax: (+1 707) 578 08 69  
info@lemousa.com